

**NEW COURSE IN TELEVISION**

# **RADIO NEWS AND SHORT WAVE RADIO**

**January**

***Special Features:***

- **Home Built Set Tester**
- **100,000 Ohms Per-Volt Meter**
- **Antenna Matching**
- **Dealer and Service Trends**
- **New European Station List**
- **30-60 Watt Modulator**

**25c**  
**U. S. and**  
**Canada**



**World's  
Tallest Aerial**  
**(Only  $\frac{3}{4}$  Complete)**



# HERE IT IS!

The Instruction Book  
That Thousands of  
Radio News Readers  
Asked Us To Publish

Over 130 Illustrations

Covers the  
Fundamentals  
of Radio

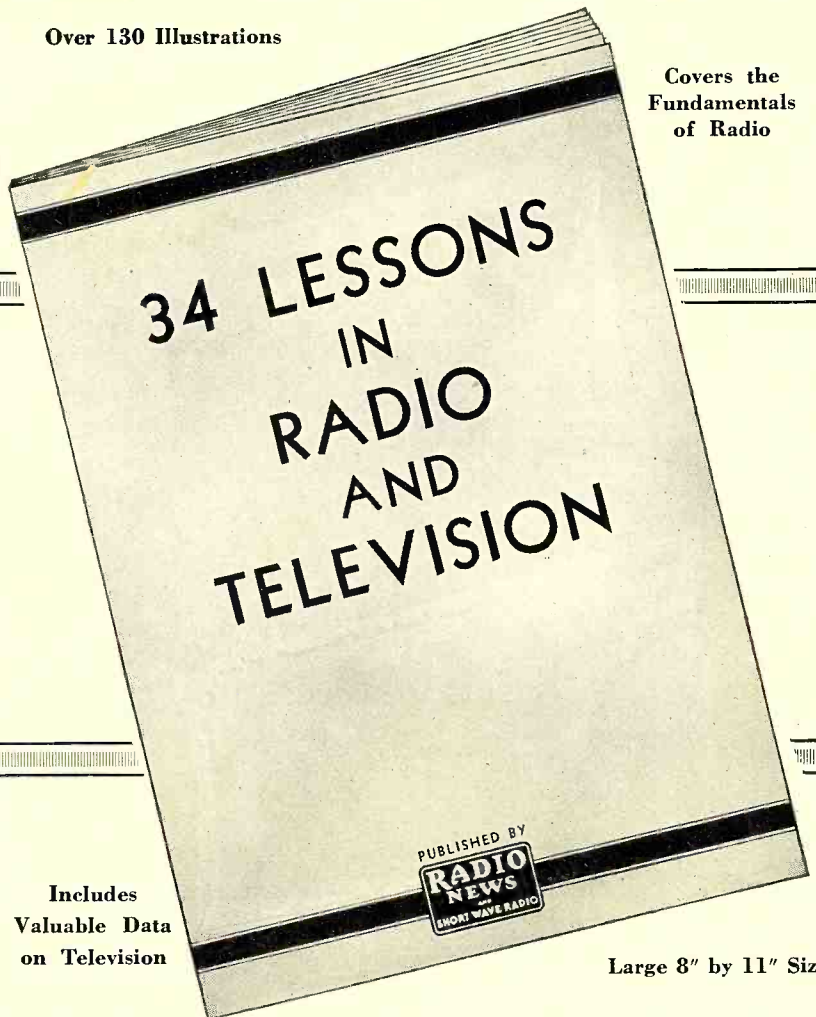

Given To You  
**FREE**  
If You Subscribe  
For 5 Issues Of  
Radio News At A  
Special Low Rate

"34 Lessons in Radio and Television" will guide you, step by step, in clear, easy-to-understand language, from the elementary theories of radio and electricity to the intricate problems involved in constructing modern radio receivers. You learn how to build carefully designed, high-efficiency receivers—and understand how and why they work! You find out how vacuum tubes operate—what radio frequency, audio frequency, regeneration and automatic volume control mean and what they accomplish—how to become a radio amateur—and all of the other information you have always sought. In addition, this book gives you the necessary background data so that you will be able to build television receivers and understand how and why they work!

#### List of Contents

"34 Lessons in Radio and Television" includes reprints of all installments of "The Radio Beginner" which appeared in RADIO NEWS from May, 1936, to June, 1937. Here is the complete list of contents: Fundamentals of Electricity—Vacuum Tubes—Reception of Radio Waves—Radio Symbols and Circuits—A Simple Diode (or Crystal) Receiver—Operation of Vacuum Tubes—Building a Simple Triode V. T. Receiver—Radio and Audio Frequency Amplification—A One-Stage Audio Amplifier—and How a Power Supply Works.

Includes  
Valuable Data  
on Television

Also, Operation of an Audio Amplifier—Fidelity of Amplifiers—Building an Amplifier-Power Unit—Regeneration—Building a Two-Tube Regenerative Tuner—Operation of Pentode Tubes—Advantages of Pentodes—Simple Tuned R. F. Receiver—Discussion of T. R. F. and Superhets—A High-Quality Broadcast Receiver—Automatic Volume Control—Oscillators and Mixers—Facts About Antennas—Photocells—Breaking Into the Amateur Game—and Code Practice Oscillators.

#### Vital Data on Television

And, of particular interest to every radio man: History of Television—Television with Kerr Cells—Scanning Disk Television—Cathode-Ray Tubes—The Sweep Circuit and Power Supply—Cathode-Ray Tubes in Television—Television Receiver Design—Present-Day Television in the U. S.—and Television Progress Abroad. You get all these

Large 8" by 11" Size

valuable lessons, written in clear, easy-to-understand language, profusely illustrated with over 130 helpful photographs, diagrams and charts, *absolutely free* in connection with our special offer!

#### HERE IS OUR OFFER:

You can get a copy of "34 Lessons in Radio and Television" *absolutely free* by placing your subscription today for 5 issues of RADIO NEWS at only \$1. (Canada and Foreign \$1.25.) Act now! Our supply of these books is diminishing rapidly! Present subscribers may obtain the free book by accepting this special offer and having their subscriptions extended for five months.

Mail the Coupon Now!

Radio News, Dept. 381  
461 Eighth Avenue  
New York, N. Y.

Enclosed find \$1. Enter my subscription for 5 issues of RADIO NEWS and send me a free copy of "34 Lessons in Radio and Television." (Canada & Foreign \$1.25.)

Name.....  
Address.....  
City..... State.....  
If you are a serviceman, check here

**RADIO NEWS**

461 Eighth Avenue

New York, N. Y.





**J. E. SMITH**  
President  
National Radio  
Institute  
Established 1914  
The man who has  
directed the  
home study train-  
ing of more men  
for the Radio In-  
dustry than any  
other man in  
America.

# I WILL TRAIN YOU TO START A SPARE TIME OR FULL TIME RADIO SERVICE BUSINESS WITHOUT CAPITAL

**HERE ARE A FEW EXAMPLES  
OF THE KIND OF MONEY  
I TRAIN MY MEN TO MAKE**



**\$200 TO \$300 A MONTH  
IN OWN BUSINESS**

"For the last 18 months I have been in business for myself, making between \$200 and \$300 a month. I have N.R.I. to thank for my start in this field."—**ARLIE J. FROEHNER**, 224 W. Texas Ave., Goose Creek, Texas.

**OVER \$1,000 BEFORE GRADUATING**  
"Before completing half the N.R.I. Course I was servicing sets, and I made \$1,000 to \$1,200 before graduating. I am doing Radio service work for myself now."—**ASHLEY G. ALDRIDGE**, 1228 Shepherd St., Petersburg, Va.



**CHIEF OPERATOR BROADCASTING  
STATION**

"When I completed 20 lessons, I obtained my Radio Broadcast Operator's license and immediately joined Station WMPC, where I am now Chief Operator."—**HOLLIS F. HAYES**, 85 Madison St., Lapeer, Mich.

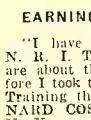

**EARNINGS TRIPLED BY N. R. I.  
TRAINING**

"I have been doing nicely, thanks to N. R. I. Training. My present earnings are about three times what they were before I took the Course. I consider N. R. I. Training the finest in the world."—**BROOKLYNN COSTA**, 201 Kent St., Brooklynn, N. Y.



Do you want to make more money? The world-wide use of Radio has made many opportunities for you to have a spare time or full time Radio service business of your own. Three out of every four homes in the United States have Radio sets which regularly require repairs, servicing, new tubes, etc. Servicemen can earn good commissions selling new sets to owners of old models. I will train you at home in your spare time to sell, install, service, all types of Radio sets to start your own Radio business and build it up on money you make in your spare time while learning. Mail coupon for my 64-page book. It's Free—it shows what I have done for others—what I am ready to do for you.

**Many Make \$5, \$10, \$15 a Week Extra  
In Spare Time While Learning**

Almost every neighborhood needs a good spare time serviceman. The day you enroll I start sending you Extra Money Job Sheets. They show you how to do Radio repair jobs, how to cash in quickly. Throughout your training I send you plans and ideas that have made good spare time money—from \$200 to \$500 a year—for hundreds of fellows. I send you special Radio equipment and show you how to conduct experiments and build circuits which illustrate important Radio principles. My training gives you PRACTICAL EXPERIENCE while learning.

**There's a Real Future in Radio  
For Well Trained Men**

Radio already gives jobs to more than 300,000 people. And in 1936, Radio enjoyed one of its most prosperous years. More than \$500,000,000 worth of sets, tubes and parts were sold—an increase of more than 60% over 1935. Over a million Auto Radios were sold, a big increase over 1935. 24,000,000 homes now have one or more Radio sets, and more than 4,000,000 autos are Radio equipped. Every year millions of these sets go out of date and are replaced with newer models. More millions need servicing, new tubes, repairs, etc. A few hundred \$30, \$50, \$75 a week jobs have grown to thousands in 20 years. And Radio is still a new industry—growing fast!

**Get Ready Now for Your Own Radio Business  
and for Jobs Like These**

Radio broadcasting stations employ engineers, operators, station managers and pay up to \$5,000 a year. Spare time Radio set servicing pays as much as \$200 to \$500 a year—full time jobs with Radio jobbers, manufacturers and dealers, as much as \$30, \$50, \$75 a week. Many Radio Experts own and operate their own full time or part time Radio sales and service businesses. Radio manufacturers and jobbers employ testers, in-

spectors, foremen, engineers, servicemen, paying up to \$6,000 a year. Radio operators on ships get good pay, see the world besides. Automobile, police, aviation, commercial Radio, loud speaker systems are newer fields offering good opportunities. Television promises to open many good jobs soon. Men I trained are holding good jobs in these branches of Radio. Read their statements in my 64-page book. Mail the coupon.

**I GIVE YOU  
A PROFESSIONAL  
SERVICING  
INSTRUMENT**



Here is the instrument every Radio expert needs and wants—an All-Wave, All-Purpose, Set Servicing Instrument. It contains everything necessary to measure A.C. and D.C. voltages and current; test tubes, resistance; adjust and align any set, old or new. It satisfies your needs for professional servicing after you graduate—can help you make extra money servicing sets while training.

**Save Money—Learn At Home  
Money Back Agreement Protects You**

I am sure I can train you at home successfully. I will agree in writing to refund every penny you pay me if you are not satisfied with my Lessons and Instruction Service when you finish my Course. I'll send you a copy of this agreement with my Book.

**Find Out What Radio Offers You  
Get My 64 Page Book Free Now**

Act Today. Mail the coupon now for my Free Lesson and my book, "Rich Rewards in Radio." Both are free to anyone over 16 years old. My book points out Radio's spare time and full time opportunities and those coming in Television; tells about my Training in Radio and Television; shows you letters from men I have trained, telling what they are doing and earning. Find out what Radio offers YOU! MAIL THE COUPON in an envelope, or paste it on a penny post card—NOW!

**J. E. SMITH, President  
National Radio Institute,  
Dept. 8AR  
Washington, D. C.**



**THIS  
FREE BOOK  
HAS HELPED  
HUNDREDS OF  
MEN MAKE  
MORE  
MONEY**

**GOOD FOR BOTH 64 PAGE BOOK FREE  
SAMPLE LESSON FREE**

- J. E. SMITH, President, National Radio Institute, Dept. 8AR, Washington, D. C.**  
Without obligating me, send your Lesson "Radio Receiver Troubles—Their Cause and Remedy" and free book about spare time and full time Radio opportunities and how I can train for them at home in my spare time—about the N.R.I. Set Servicing Instrument you give me. I am particularly interested in the branch of Radio checked below.
- Radio Service Business of My Own
  - Spare Time Radio Service Work
  - Retail Sales of Radio Sets and Equipment
  - Service Expert for Retail Stores
  - Broadcasting Station Operator
  - Aviation Radio Operator
  - Ship Radio Operator
  - Loud Speaker Systems, Installations and Service
  - Auto Radio Installation and Service
  - Television Station Operator
  - Service Expert with Radio Factory
  - Commercial Radio Station Operator
  - All-around Servicing Expert
- (If you have not decided which branch you prefer—mail coupon now, for information to help you decide.)

**Get My LESSON on  
Radio Servicing Tips FREE**

I'll prove that my Training gives practical, money-making information, that it is easy to understand—that it is just what you need to master Radio. My sample lesson text, "Radio Receiver Troubles—Their Cause and Remedy" covers a long list of Radio receiver troubles in A. C., D. C., battery, universal, auto, T. R. F., super-heterodyne, all-wave, and other types of sets. And a cross reference system gives you the probable cause and a quick way to locate and remedy these set troubles. A special section is devoted to receiver check-up, alignment, balancing, neutralizing, testing. You can get this lesson Free by mailing the coupon.

**MAIL  
COUPON  
NOW**



**The Tested WAY  
to BETTER PAY**

NAME ..... AGE .....  
ADDRESS ..... 14X1





Edited by LAURENCE MARSHAM COCKADAY

S. GORDON TAYLOR  
Managing Editor

WILLIAM C. DORF  
Associate Editor

JOHN M. BORST  
Technical Editor

JOHN H. POTTS  
Assoc. Tech. Editor

BILL EVERETT  
Art Editor

Vol. XIX, January, 1938, No. 7

## Reading Guide to this Issue—

AMATEURS—3, 6, 8, 9, 10, 11, 12, 17, 18, 20, 22, 24  
BROADCAST FANS—2, 8, 13, 14, 17, 18, 22  
DEALERS—1, 4, 5, 6, 8, 9, 11, 12, 16, 18, 22  
DESIGNERS—6, 7, 8, 11, 18, 20, 22  
DX FANS—2, 8, 13, 17, 18, 22, 23  
ENGINEERS—6, 8, 11, 14, 18, 20, 22  
EXPERIMENTERS—3, 4, 6, 7, 8, 11, 14, 17, 18, 20, 22  
MANUFACTURERS—8, 18  
OPERATORS—3, 8, 18, 20, 21  
SERVICEMEN—1, 3, 4, 5, 6, 7, 8, 18, 20, 22  
SET BUILDERS—3, 4, 6, 8, 9, 12, 17, 18, 20, 22  
SHORT-WAVE FANS—8, 15, 16, 17, 18, 24  
STUDENTS—1, 2, 3, 4, 5, 6, 7, 8, 11, 14, 17, 18, 19, 20, 22  
TECHNICIANS—3, 6, 7, 8, 18, 20, 22

### Next Month

ANOTHER development from the laboratory of Raymond P. Adams, on which constructional details will be presented in the February issue, takes the form of a high-fidelity receiver. Among its features are a 2-stage, variable band-pass t.r.f. amplifier; voltage-doubling diode detector; push-pull audio stages and 2A3's in the 12-watt output stage. This is the sort of design that many advanced constructors have been awaiting for use where high-quality reception from local broadcast stations is the important consideration.

1	Serviceman's Diary.....	Anonymous	388
2	Seventeen Years of Broadcasting.....	W. W. Rogers	391
3	Practical Lessons in Television (Lesson 1).....	F. L. Sprayberry	394
4	The Single-Unit Servicer.....	Allen J. Loeb	397
5	Service—Sales.....	Zeh Bouck	400
6	100,000-Ohms-Per-Volt Voltmeter.....	Gerard J. Kelley	402
7	Set Tester Design Considerations (Part 1).....	Samuel C. Milbourne	404
8	At Your Dealer's.....	William C. Dorf	406
9	80-Watt C.W. Rig (Utah Kit No. 1).....	Oliver Read	407
10	The "Ham" Shack.....	Everett M. Walker	408
11	The New 833 Tube.....	Robert Ames	409
12	The R. N. Progressive Transmitter (Part 2).....	Watzel and Bohlen	410
13	Station List (Europe).....	John M. Borst	412
14	New Unit Tests Voices.....	Samuel Kaufman	413
15	The DX Corner for Short Waves.....	Laurence M. Cockaday	414
16	World Short-Wave Time-Table.....		416
17	ABC's of Antenna Design (Part 2).....	I. Queen	419
18	Radio News Index (July-December, 1937).....		420
19	Students' Radio Physics Course.....	Alfred A. Ghirardi	424
20	The Technical Review.....	The Technical Editor	426
21	Q R D?.....	By G Y	428
22	Free Booklet Service.....		430
23	The DX Corner for the Broadcast Band.....	S. Gordon Taylor	432
24	The Amateur Observer.....	W2JCR	438

Published Monthly by Teck Publications, Inc., Washington and South Avenues, Dunellen, N. J.

#### EDITORIAL AND EXECUTIVE OFFICES

461 EIGHTH AVENUE, NEW YORK CITY, N. Y.

Entered as second class matter at the Post Office at Dunellen, N. J., under the act of March 3, 1879. Copyright, 1937, by Teck Publications, Inc., in U. S. and Canada. All rights reserved. Registration of title of this publication as a trade mark applied for in the United States Patent Office. Printed in the United States of America. The contents of this magazine must not be reproduced without permission. We cannot be responsible for lost manuscripts, although every care is taken for their safety.

25c a copy. Subscriptions, \$2.50 a year, \$4.00 for two years; in Canada and Foreign Countries \$3.00 a year, \$5.00 for two years. Subscribers are notified that change of address must reach us five weeks in advance of the next date of issue.

Lee Ellmaker  
President and Treas.  
B. Holcepl  
Secretary  
Walter C. Freeman  
Eastern Advertising Manager  
Virgil Malcher  
Western Advertising Manager  
605 N. Michigan Ave., Chicago  
Tel. Superior 8938





READ TO THE FAR CORNERS OF THE EARTH

*"It is perfectly amazing to note some of the far corners of the earth to which your publication, RADIO NEWS, is distributed and read. We are receiving inquiries, daily, from practically every country in the world where products such as ours are used and we find that the majority of them are from readers of RADIO NEWS. Our export business has been increasing every year, and while we feel that the quality of our products has a lot to do with this increase we know that we are indebted to your publication for bringing our products to the attention of our present customers in other lands."*

Export Manager  
AEROVOX CORP.



## Pages From A Serviceman's DIARY

**SATURDAY:** Calls piled up rapidly this morning, all wanting service "pronto" so they can listen to the football games. About one-half the jobs will call for shop work so the only way we can keep the customers satisfied is to leave a set on loan while the defective ones are being fixed. Accordingly, I gathered together a few trade-in midgets, as well as new ones, and started out. Some of them, I hope, will stay put as extra sets. (Which won't be so bad for all concerned.)

Stopped at the doctor's home first, where the push-button switch on the old RAE-79 wouldn't operate the relay. Found the copper contacts on the relay badly burned so picked up the chassis for a shop repair. We'll put in double contacts on the repair and shunt the points with a condenser to keep down the sparking.

### A Nervous Wife

The doctor's wife is a very nervous individual and worries a lot when the doctor is called out at night. They have two children and the house is in a rather lonely spot so perhaps she can't be criticized, since there have been a number of burglaries recently in this neighborhood. I mentioned our photo-cell burglar alarm, which rings a large bell and suggested that it be installed to operate when anyone tries to pass from the office to the living quarters. She seemed much interested and I arranged a demonstration on Monday at a time when the doctor would be home.

Next, a Stromberg 846. The middle-aged school teacher who met me at the door showed me a pair of pliers she had been using to turn the dial-drive shaft, which was binding badly. The tuning knob had been removed, since the inner spring had bent flat under the strain (no use trying to take the shaft apart to clean and lubricate it—a new one costs only sixty cents). Had it with me so made the replacement on the spot. Mentioned the burglar alarm to her too but—no go! She is unmarried and perhaps would welcome a visit—even a burglar. I imagine she looks under the bed every night before retiring to see if a man is hiding there.

Ran off a couple of tube replace-

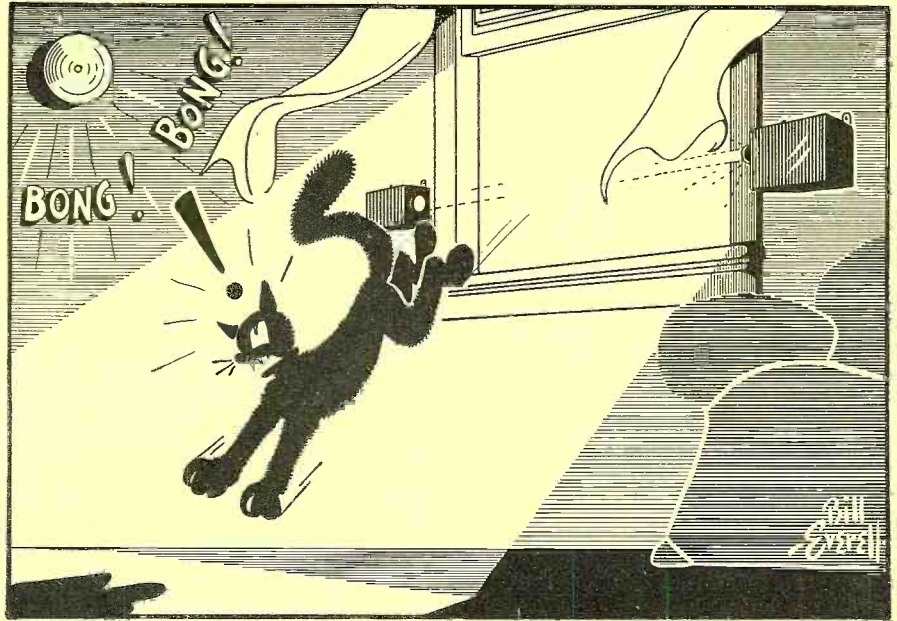

### FELIX'S ARRIVAL WAS ALWAYS VERY WELL ANNOUNCED

*The installation of photo-electric burglar alarms offers a new and substantial sideline for service-dealers, but don't make the mistake that one serviceman did. He installed a very fine system for a customer, not knowing that there was a cat in the family. The window was on the ground floor and Felix's arrival at 3 a. m. after a midnight stroll woke up the whole family with a burglar scare until they discovered that Felix was the "Midnight Marauder".*

ment jobs, then returned to the shop for lunch.

Replaced a condenser in an old Majestic B eliminator, used with a discarded battery set in the servant's quarters of one of the larger homes near the shop. This was promised for the afternoon so I had to drop it off. They'd be a lot better off to get another set. But some like to hang on to these decrepit old machines, remembering the high original cost and feeling that therefore the performance must be superior to the cheaper new sets. Some, also, get so accustomed to bad reception that they can't appreciate a really good set.

### Noisy Volume Control

Moved on to a Radiola 48 which was acting up again. We'd installed a new volume control about a year ago. Time flies for customers, though, and the owner had to be shown our record card in order to be convinced that the job had been done more than three months previously. The cadmium plating had begun to flake off

the gang condenser, creating a raspy noise when tuning. This trouble hadn't been present before but perhaps we should have given it a treatment on general principles. We disconnect all leads from the variable condenser and then apply 600 volts between each stator assembly and ground, with the stator plates meshed. This burns off any projecting burrs which may be present.

Cut the price for the job to a minimum, left a set on loan and went to the next sufferer. This proved to be one of the bronze-finished Fada models, equipped with a neon-tube resonance indicator. The Italian woman who owned it could not be termed a stylish-stout. She was so fat that she actually created a draft as she sailed into the room, with several dirty-faced youngsters peering from behind her skirts.

### Resonance Indicators

The neon-tube wouldn't light—therefore it must be burned out, she was certain. Unfortunately, these resonance indicators have a disgustingly long life from the serviceman's standpoint. I pulled out the chassis and temporarily short-circuited a portion of the voltage divider which provides the biasing potential for the tube. Sure enough, it flashed okay. But it was hard to explain that the voltage-divider resistors had changed in value and needed replacement. "Why couldn't I just put in a new tube and try it without monkeying

(Turn to page 425)

**T**HESE records from an anonymous serviceman's diary should be of decided interest to veteran servicemen, as well as to those whose experience in the service field is more limited. Written by a man who "knows his stuff," and shot with an occasional outcropping of humor, these items provide many hints not found in text books. More of these pages will appear from time to time.



# MY FREE BOOK *and* FREE LESSON

**SHOW HOW TO MAKE  
\$15—\$20 A WEEK SPARE TIME—  
\$35—\$75 A WEEK FULL TIME  
IN RADIO**



"\$100 A MONTH SPARE TIME"

"Last year I worked on a farm for \$25 per month. Now I am making about \$100 per month in spare time Radio work. My prospects are good, because a large battery and electric company has asked me to locate my shop at their place of business. Several other men without your training wanted to locate there, but the owner did not think they knew enough about Radio. Your training has given me a bright outlook for the future."  
—Merlyn Hansen, Atlantic, Iowa.

**T**HERE is real money in Radio for men who are trained the right way. I offer you a new kind of proved and tested Radio training that actually sets you up for business and prepares you for a well-paid job in any one of Radio's many fascinating branches. Men taking my training right now are earning \$15 to \$20 a week in spare time—while they learn. Men who have graduated are holding down jobs paying \$35 to \$75.

My course is arranged to give you practical lessons right at the start. My free book and free lesson will show you this. I train you to make quick cash from simple jobs almost at the beginning. Quickly, you are ready to begin servicing sets. Useful, simple job sheets show you every step to take. Also, I send you genuine professional equipment—a feature of training rarely offered.

**NO EXPERIENCE NEEDED**

Old-timers and newcomers are making more money in Radio as a result of my training. If you are in Radio now, you know that now is the time to get extra technical training. If you are just starting in Radio, now is the time to get started on the right track. Learn Radio the right way—not "the hard way"; I make it easy for you.

**SERVICE MEN NOTE!**

I have a special advanced course for you. This is fully described in my big free book, "More Money in Radio." Get the facts about my training. Get my free book and free lesson. The coupon is good for both—mail it to me today.

**MAKE GOOD MONEY  
FOR YOURSELF  
SERVICING RADIO SETS**

**THIS COMPLETE  
"Radio Shop"  
EQUIPMENT COMES  
WITH MY COURSE**

Take note of the fact that I train you on real professional equipment which becomes your personal property. This equipment is practically a complete Radio shop. See the picture below: you get a big professional 1181A Triplett tester, a complete seven-volume set of the famous Rider manuals, genuine Eby electric eye outfit, a full set of tools, etc., everything you need.

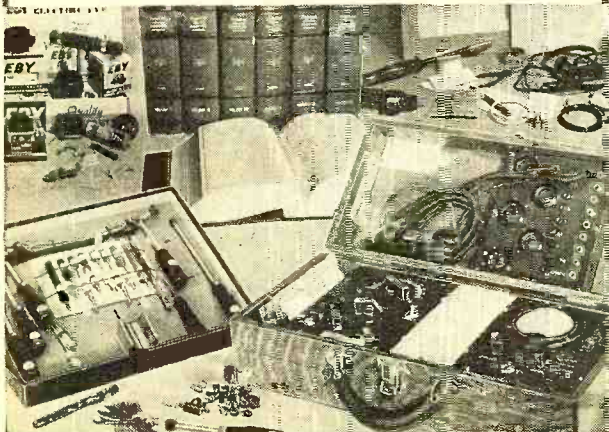

"FULL VALUE"

"I hardly feel that I have paid you for the full measure of value received from your course. I have taken other Radio training which was good, but from the practical angle your course did me the most good. The schematic diagrams in the lessons and the data sheets were a great help. I am going to keep the course right on my work bench, so I can use it for a reference in solving service problems as they come up."  
—Fred P. Steinmetz, Chandler, Indiana.

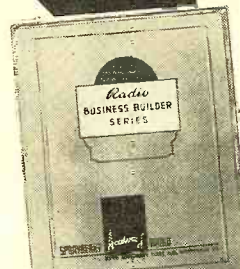

**MAIL AT ONCE**



**SPRAYBERRY ACADEMY OF RADIO**  
F. L. Sprayberry, President  
125-A, University Place, N. W.  
Washington, D. C.

Please send me at once your free book, "More Money in Radio," and also a free lesson, showing how your training prepares for spare time cash.

Name ..... Age .....

Address .....

City ..... State .....

Paste this coupon on a penny postcard and mail today.  
If interested in service course only, check here.



# Step up Servicing Profits by making more repairs per day

**ONE STEP ISN'T ENOUGH**  
**NEITHER ARE TWO**  
**IT TAKES THREE!**

**ACCURATE KNOWLEDGE OF RECEIVER CIRCUIT**  
**EASY AVAILABILITY OF QUALITY REPAIR PARTS**  
**CORRECT INSTALLATION INFORMATION**

**ACCURATE KNOWLEDGE OF RECEIVER CIRCUIT**  
**EASY AVAILABILITY OF QUALITY REPAIR PARTS**  
**ACCURATE KNOWLEDGE OF RECEIVER CIRCUIT**

**Only MALLORY-YAXLEY**  
P. R. MALLORY & CO., Inc.  
**provide all three steps to profit**

Three steps are necessary in successful, profitable servicing:

- (1) Accurate knowledge of the receiver circuit to permit prompt diagnosis of the trouble.
- (2) Easy availability of the required quality repair parts.
- (3) Complete information on the methods of making the correct installations.

Only Mallory-Yaxley give you the help you need at *all three stages!*

The Mallory-Yaxley Radio Service Encyclopedia provides circuit information—*analyzed and simplified* to save you time and effort.

Mallory-Yaxley Precision Radio Products are designed on a basis of straight-forward engineering in which penny-pinching plays no part. They are not mere duplicates of manufacturers' original equipment. Every feature contributing to universal application is added, so that the inventory required to maintain a complete stock of repair parts is amazingly small. This means that you can get the correct part you want *when you want*

*it*—there is no tedious waiting for delivery from some factory.

Mallory-Yaxley products are easy to use. They are neither tricky nor obscure in design. But—where unusual receiver construction necessitates special treatment in installing the replacement, you will find that the Mallory-Yaxley Radio Service Encyclopedia provides complete notes that tell you the simple, easy ways to make the required repairs.

Use Mallory-Yaxley Precision Radio Products—use the Mallory-Yaxley Radio Service Encyclopedia—and take full advantage of *the three steps to profit* that only Mallory-Yaxley provide!

## *And now . . . what will Mallory-Yaxley do next?*

That's the question asked each year throughout the entire radio replacement field. And—it's a question that is always answered with *sensational advances* that promote more profitable servicing! What Mallory-Yaxley will *do next*, will enable you to *do more*—and *make more*—throughout 1938. Watch for the major announcement of the New Year!

Use

P. R. MALLORY & CO., Inc.  
**MALLORY**  
REPLACEMENT  
CONDENSERS . . . VIBRATORS

P. R. MALLORY & CO., Inc.  
INDIANAPOLIS INDIANA

Cable Address — PELMALLO

Use

**YAXLEY**  
REPLACEMENT  
VOLUME CONTROLS



# Radio News

Volume XIX

January, 1938

Number 7

## Seventeen Years of BROADCASTING (KDKA Installs Tallest Antenna)

**T**O Eskimos who, like almost everyone else, heard their first radio broadcasts from KDKA, those call letters still are synonymous with broadcasting itself. Now radio listeners in every clime are sharing the Eskimo's sentiments, joining with a world's pioneer commercial broadcasting station to celebrate its anniversary—the seventeenth.

Significantly enough, the high point of this seventeenth year of service was the dedication of another "first" in radio—the world's most modern and efficient antenna, a 718-foot steel "cloud-scraper" located at nearby Saxonburg, which will give primary service over an area ten times greater than that formerly provided with strong, clear signals. This sixty-ton spire, its top half often obscured by clouds, is now in operation.

The new antenna, like the other modern equipment in KDKA's present spacious quarters in the Grant Building, signalizes the amazing advances made by radio in seventeen brief years. It was November 2, 1920, that the original KDKA, housed—studio, sending equipment, technicians, talent all together—in one big room at the Westinghouse Headquarters Works in East Pittsburgh, flashed the news of Warren G. Harding's election to the few owners of amateur receiving sets then in existence. That daring venture inaugurated a daily program over KDKA which has continued without interruption for seventeen years. It also marked the beginning of commercial radio broadcasting.

### First Station

The original KDKA stemmed from experiments by Dr. Conrad in his Wilkesburg, Pa., garage going back to 1912.

**T**HE world's highest antenna is now in service at Saxonburg, near Pittsburgh. It is of welded-steel construction, weighing 60 tons and 718 feet high. The whole weight of the tower is borne by a single porcelain insulator.

By W. W. Rogers

### NIGHT VIEW OF THE TOWER

*The vertical line of lights above the station house glow in the darkness as searchlights illuminate the slender but tremendous tower.*

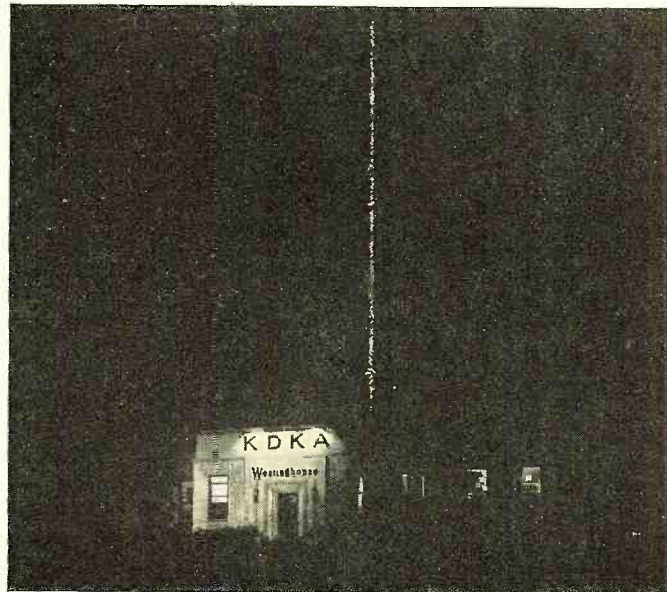

Before the World War Dr. Conrad had successfully "corresponded" with many radio amateurs in the United States. After developing a practical airplane radio transmitter for the government, Dr. Conrad returned to civilian life convinced that radio held even greater possibilities.

His first venture in broadcasting was with phonograph records borrowed for the purpose from a neighborhood dealer. Later he spiced his programs with vocal and instrumental talent. Soon a Pittsburgh department store began advertising receiving sets with which amateurs might pick up Dr. Conrad's popular broadcasts. To H. P. Davis, Westinghouse Vice-President and later Chairman of the Board of the National Broadcasting Company, the advertisement was an inspiration. Out of that inspiration came KDKA.

In the first few months of its operations program material still was drawn largely from Dr. Conrad's first source—phonograph records. Casting about for new and interesting variations, the Westinghouse Company turned to its own employees, who had a number of musical organizations, among them a very good band. When the band proved an enormous success with the fast-growing radio public, the KDKA Little Symphony Orchestra was formed.

### Tent Used

These larger aggregations of talent necessitated seeking larger quarters, so one of the Company auditoriums was pressed into service. But auditoriums of even the most modern type in those days were not suited to radio broadcasting, and room resonance soon drove the musicians into the open air. A tent was set up on top of one of the buildings and served



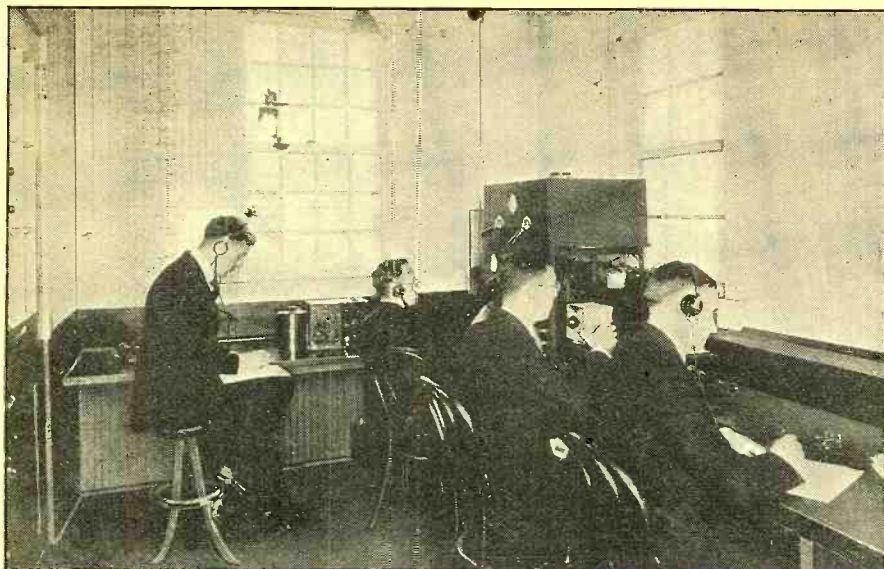

THE COMPLETE STATION AS IT WAS IN THE YEAR 1920

*Here you see all there was to the original KDKA. The transmitter is in the corner of the room, with the station engineer making adjustments. Two line operators, extreme left and right, are shown copying news reports of the Harding-Cox election returns. The announcer reads the returns into the box microphone.*

admirably until a high wind blew it away in the fall of 1921.

Forced to move indoors again, the engineers tried pitching the tent in a room. It worked. The next step saw the tent removed and the walls of the room draped with burlap. A far cry from today's specially constructed non-resonant walls and ceilings, but the forerunner of the monk's cloth drapes still used in some studios.

### Now on Super Power

Today KDKA operates on 50,000 watts. Seventeen years ago its power was only 100 watts, but even that caused its complications. Too powerful for the homemade receiving sets of the amateurs who previously had had the air to themselves, KDKA soon found itself confronted with a serious problem. But by the end of 1921, an unprecedented public interest that swamped an infant industry with demands for more of what KDKA had been giving it, convinced amateur senders they would have to adjust themselves to the young giant.

### Early Innovations

Radio broadcasting became a conversational topic as universal as the weather. A scientific novelty had become a public service. Each new addition to the program repertory brought in a wider circle of avid listeners, for KDKA early in its history departed from the purely musical routine to introduce a broader range of material.

One of the early innovations was the broadcasting of a full regular church service. That was not as easy as it sounds today, for most people, and probably most ministers, still regarded radio as a medium of unprov-

en value. One, however, the Rev. Dr. E. J. van Etten, Rector of Calvary Episcopal Church, Pittsburgh, shared the enthusiasm of Westinghouse engineers for the new means of communication. On January 2, 1921, Dr. van Etten's voice went over the air—the first to broadcast a divine service.

### Features Broadcast

On January 15, 1921, KDKA carried Herbert Hoover's first broadcast, an appeal for funds for European relief at the Duquesne Club, Pittsburgh. On February 15 of that year KDKA transmitted an address by Miss Alice M. Robertson of Oklahoma, the nation's first Congresswoman.

One of the earliest and most popular innovations was the retransmission of Arlington Time Signals with which KDKA for years "signed off" its nightly programs. Sports events were broadcast by KDKA—a boxing bout between Johnny Ray and Johnny Dundee in Motor Square Garden, Pittsburgh, on April 11, 1921, being the first. On May 9, 1921, KDKA broadcast from the stage of the Davis Theater in Pittsburgh a complete theatrical program. On August 5, the station transmitted a play-

by-play baseball account from Forbes Field, Pittsburgh. That same month it broadcast running comment on the Davis Cup matches at the Allegheny Country Club, Sewickley, Pa. Both radio and "Big Bill" Tilden were just beginning in those days; the fact that both are still going strong is graphically illustrative of the industry's youth.

In the constant effort to develop a diversified program, KDKA was the first radio station to attempt a regular farm service, which included not only livestock, hay and grain reports, but also weather forecasts. On May 19, 1921, KDKA was authorized to broadcast government market reports.

### Instruments Introduced

In the beginning all sorts of persons were pressed into service as announcers, willingness being the prime requisite. Soon it was discovered that training in diction and pronunciation was necessary, since for every mispronounced word there were many letters from listeners. An Announcer's School began to take out kinks.

One of the early fundamental problems that had to be surmounted had to do with the fact that characteristics of the microphone were quite different from those of the human ear. Studio groupings and the laws that govern them were unknown in those pioneering days, but A. G. Popcke, a Westinghouse engineer, soon worked out a chart showing the proper location of soloists and piano, and of instruments in various combinations from trios to symphony orchestras.

### Modulation Controlled

To provide a means for controlling the varying musical tones, a modulation meter calibrated from 1-100 was devised. This instrument has since become standard equipment in

### "PLOUGHING UNDER" COPPER WIRE AT KDKA

*For the new ground system at Saxonburg 50 miles of wire was buried in 700-foot lengths radiating from the central tower. A tractor and a specially fitted plow dug a shallow trench one foot deep into which the wire was laid.*

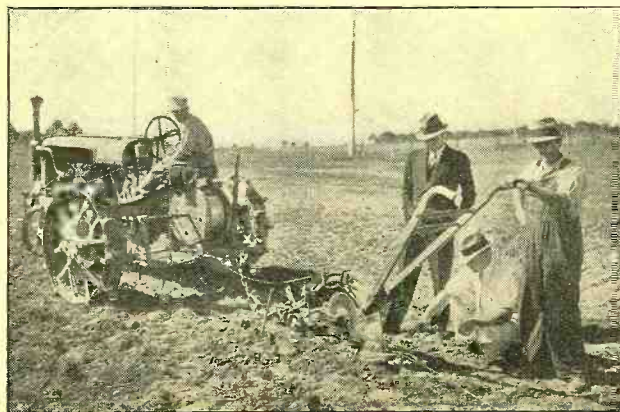



every transmitter. It is used to study the effect of different kinds of music or frequencies upon the current in the modulating tubes—an important factor that determines the quality of broadcasting, since over-modulation causes distortion, and under-modulation gives too weak a signal, difficult to reproduce clearly on the receiving sets.

**Short Wave Pioneering**

Meanwhile, KDKA was reaching out and pioneering in a branch of development of the radio art which now bids fair to be the most important in the entire science of communication—short wave transmission.

Even prior to the establishment of KDKA as a station, Dr. Conrad had become convinced of the value of short waves, and by 1922, he had convinced associates that possibilities were being overlooked in the then unused and rather despised short-wave bands. An experimental station known as KDPM was installed in Cleveland, and serious work was undertaken between it and KDKA. In the fall of 1923, the company located a rebroadcasting station, KFKX, at Hastings, Nebraska, which nightly received and re-broadcast KDKA programs.

**Heard in Australia**

On New Year's Eve, 1923, through previous arrangements, KDKA transmitted a short-wave program to Great Britain. On December 12, 1924, KDKA's short-wave program was received and re-transmitted in Johannesburg, South Africa, by a news-

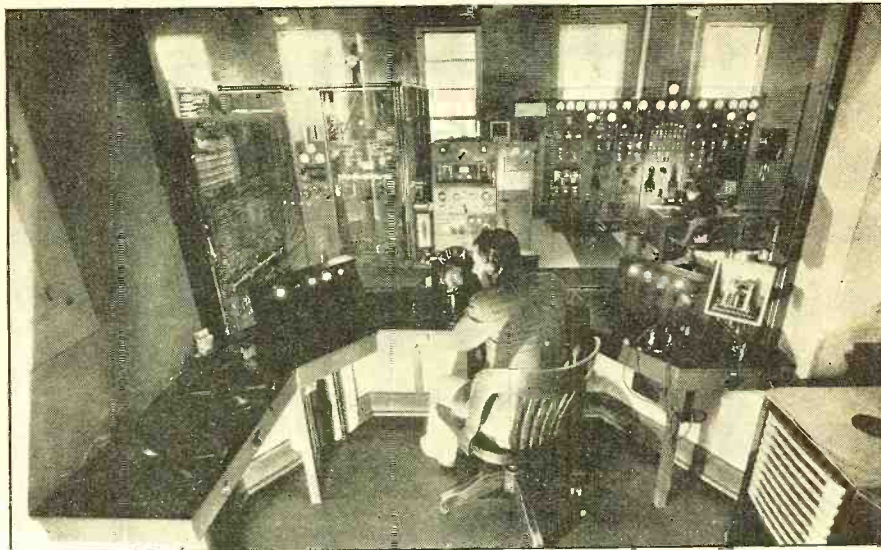

1937—WHAT A DIFFERENCE IN THE MODERN KDKA!  
The modern transmitter room as viewed through the windows of the control room, which is a distance of 20 miles from the original studios in Pittsburgh.

paper there, the Johannesburg Star. A few weeks later KDKA transmitted a program to Australia.

In 1926, KDKA and sister Westinghouse stations, among them WJZ, then located at the Westinghouse Works in Newark, N. J., were the first to become member stations of the great National Broadcasting Company chain which was then forming.

So it is that, after eleven years of association in the continued improvement of radio facilities, Westinghouse and NBC join in signaling past and present achievements.

**Phenomenal Success**

In seventeen years broadcasting stations have multiplied into many thousands. A modest experiment in one room has become a billion-dollar industry. A world of entertainment and information undreamed of a few years ago is at the constant beck and call of everyone, at no charge other than the initial cost of a radio receiver.

Yet in spite of the rapid strides made in the industry, in spite of the growing competition everywhere, the new giant antenna at Saxonburg vin-

dicates an early antenna design of Dr. Frank Conrad, just as the whole institution of radio and its phenomenal success justify this great engineer's faith in it at a time when few believed that the transmission of sound without wires would ever become perhaps the greatest single force in history.

**Ten-Fold Improvement**

KDKA's new antenna system is giving primary broadcasting service over an area ten times greater than that previously provided with strong, clear radio signals. Principal elements of the improved radiating facilities are the main antenna, a steel spire towering 718 feet high, and a circle of eight 90-foot antennas designed to suppress interfering waves normally emitted in radio transmitting. Vertical antennas of the type now installed at KDKA radiate both ground and sky waves. When these two waves meet in areas of varying distance from that station they interfere with each other to cause fading or mushy program reception. The ring of shorter towers also radiate skywaves but in opposite directions to nullify the effect of the skywave emitted from the main antenna. The fading zone is thus extended to great distances from the station and broadcast service vastly improved.

**Welded Steel Tower**

So high that its top half is often obscured by clouds, KDKA's spire is composed of thirty-two three-cornered welded steel sections. Only five feet wide, these sections are bolted together. Two sets of long guy wires hold the antenna upright. The 60 ton structure rests in the ball-and-socket joint of a single large porcelain insulator, (Turn to page 444)

**A TICKLISH CONSTRUCTION JOB**

*These steel riggers look happy! And they ought to be, for they are on their way down after finishing the construction of the world's tallest welded-steel tower. The man looking up (in the smaller photo) may well wonder how these insulators and such a slender base can support the structure.*

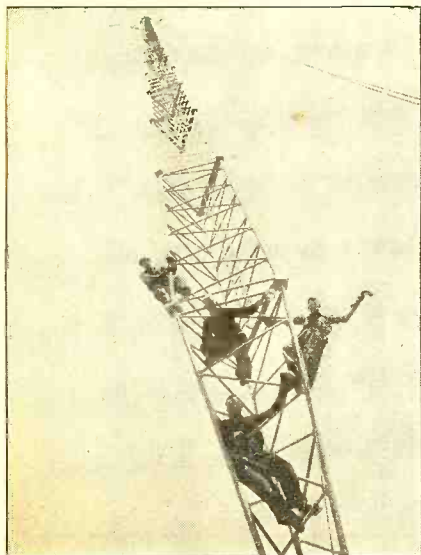



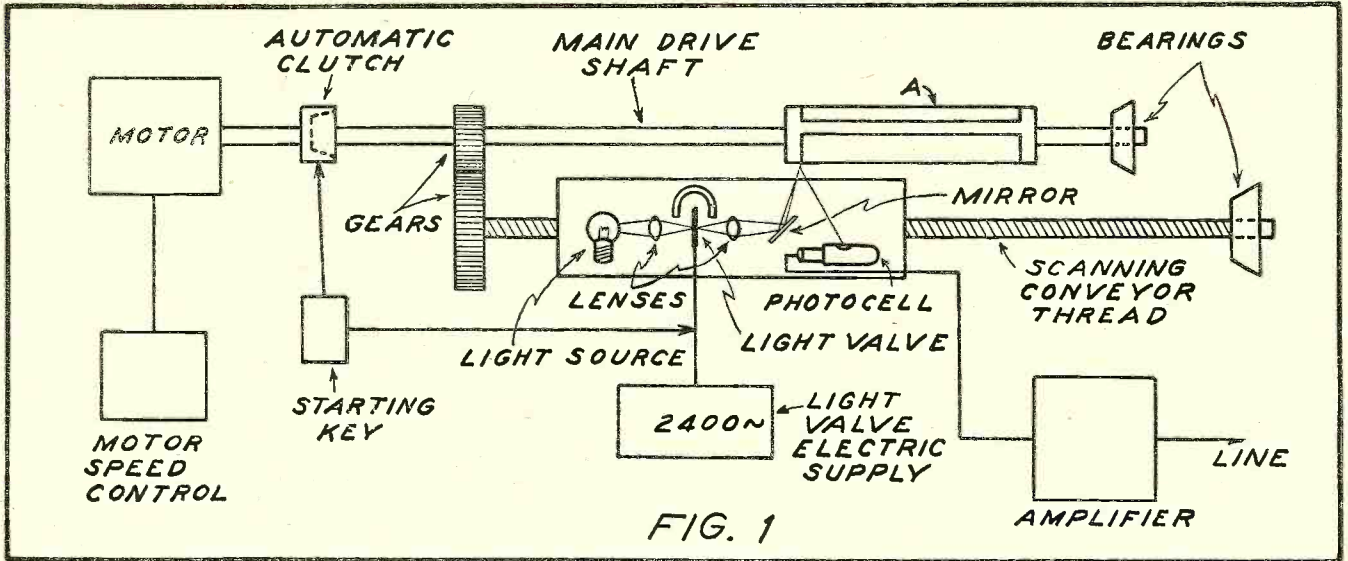

# Practical Lessons in TELEVISION

(Lesson One: Sending a Picture)

PERHAPS the most basic of all the ideas utilized in Television to the present day was brought forth even before the twentieth century by P. Nipkow, who was a Polish scientist. He had no thought of television in mind at the time, as this was in 1884, before the practical telephone or the practical use of the electric light bulb. Scarcely three years before this, Thomas A. Edison exhibited the first incandescent lamp in Paris, using the carbon of a small splint of bamboo as the filament. It hardly seems possible that television got its start almost with the incandescent lamp, but it had to await development of subsequent arts before these items could be borrowed and adapted for its use. To grasp the full significance of television in its present form, we must turn from electricity, to physics,

LIKE all developments of present-day scientific marvels, television to the uninitiated seems to be too complicated for even a mediocre understanding. But such is not really the case if the layman is first presented with the fundamental ideas involved. Television has borrowed these ideas from so many different arts and its development has taken such an indirect course that its exact beginning may seem somewhat obscure. We can, however, trace its development from the various sources and present these ideas so that any interested person can grasp the principles without too much difficulty. This series begins with a description of picture transmission and elementary "scanning." If you are a radioman, it is important that during the next year you learn what television is and how it is accomplished. Start today and don't miss a single lesson.

By F. L. Sprayberry

to optics, to electronics and to chemistry as readily as a linguist may turn to one of many languages. Rather than a handicap to this study, we will find that this is really an advantage because of the similarity of each branch of science to others and the theories applying to one branch fitting another just as perfectly.

### Picture Transmission

Were we studying moving pictures as employed in the theatre, we would naturally start with the projection of our picture and then simply show how the means were applied to project a

number of slightly different pictures in rapid succession to give the illusion of motion. So it is with television, we start with the transmission of one picture and then show what means are required to perform the same basic operation many times per second to also give the illusion of motion in the succession of slightly differing pictures.

Only a small percentage of people realize today that a great number of pictures are sent by wire for newspapers and that the art of Wire Photography, also called Telephotography, has advanced to a highly refined stage. A picture may be taken with an ordinary camera in Seattle, Washington, for example, from which a negative may be made and sent to the location of the picture transmitting equipment. To the telephone

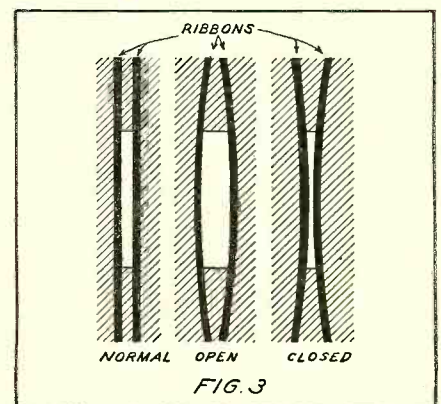
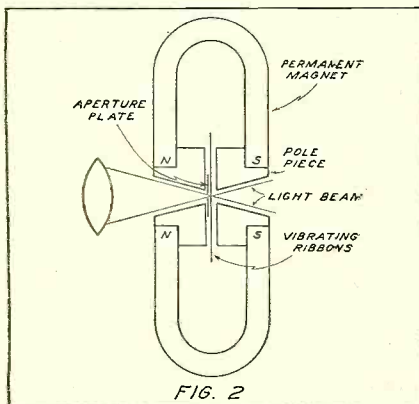



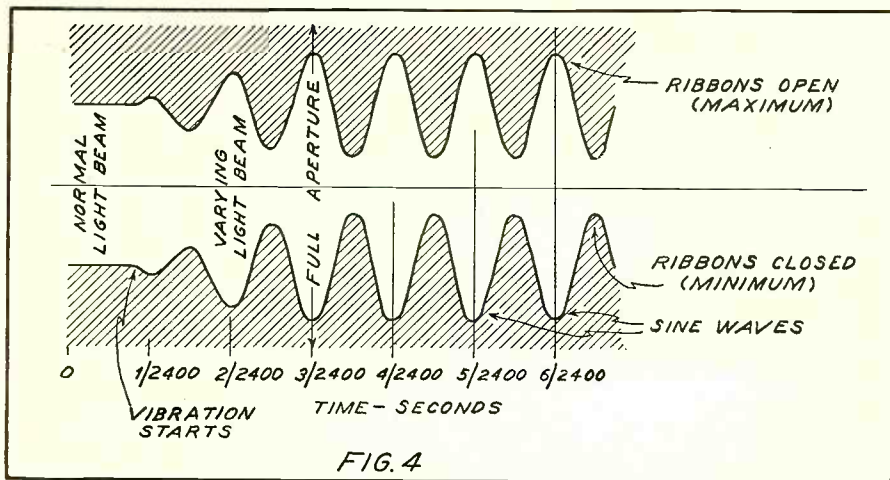

FIG. 4

**HOW A LIGHT GATE WORKS**

Figure 4. Showing how the ribbons, upon opening and closing, modulate the light intensity.

lines may be attached any number of picture receiving units and within a short time the picture may be showing on the news-stand in twenty-five or more cities all over the United States. This may be extended to foreign countries as well, through the use of a radio in place of a wire line.

Let us look into the details of this process as it will be a big step in the understanding of modern television. In Figure 1 is shown a diagram of a picture transmitting equipment. Any photograph up to 11 by 17 inches is placed on the cylinder "A" with its back toward the cylinder, usually with its longer dimension along the length of the cylinder. Means are provided for clamping the photograph onto the surface of the cylinder. The latter is approximately 3 3/4 inches in diameter or 12 inches in circumference, so that only a 1-inch space is left along the cylinder if an 11-inch picture is used. The cylinder is rotated by means of a speed-controlled d.c. motor through an automatic clutch on its shaft at exactly 100 revolutions-per-minute. A reduction gear mechanism on the cyl-

inder shaft and an auxiliary shaft serves to drive a long threaded shaft beside the cylinder and parallel to it. On this shaft is mounted an assembly which it moves at the rate of 1 inch per minute in exactly the same manner that a cutting tool is carried along the "work" on a metal lathe. Of course, the gear ratio and the pitch of the thread on the second mentioned shaft is made to provide this speed of rotation and of movement of the assembly. In this assembly is housed the means for resolving the picture into a signal ("dissecting" or "scanning") for transmission. The light from an ordinary electric lamp, actually an automobile headlight lamp, is focused on a fixed mirror through a mechanical light valve. The mirror reflects the light beam onto a spot on the picture, one hundredth of an inch square which in turn reflects the remaining light back into the assembly and onto the cathode of a photoelectric cell.

**How It Works**

Suppose we now turn to a study of how these pieces of apparatus are capable of producing a signal by which a picture may be rebuilt. The light is of constant intensity and by means of the lens between it and the light valve, is focused almost to a point at the light valve. The light valve consists of two ribbons connected at one end forming a hairpin loop suspended in a powerful magnetic field. As seen in Figure 2, this field is constructed somewhat like a dynamic speaker field except that the air gap between the two magnet poles is flat and rectangular instead of cylindrical and per-

manent magnets are used. A hole in the center of the magnet is provided and it is fitted with a metal plate with a slit about 1/4 inch long and .01 inch wide. In passing through this slit or aperture the light next comes to the two ribbons as in Figure 2. An alternating current of 2400 cycles is impressed on the two open ends of the two ribbons and they vibrate at 2400 cycles because of the action of the main permanent magnetic field on the 2400 cycle field. The action of the two fields, one due to the permanent magnets and one due to the 2400 cycle current moves the ribbons "laterally" across the permanent magnetic field. When in their normal positions they partially conceal the total light "gate" or aperture as in Figure 3. When the ribbons separate, more light may pass through the gate, but when together very little light may pass. As current is flowing down one ribbon, it flows up the other one, thus they move in opposite directions.

**What the Graph Shows**

At high speed these ribbons move in a wave-like manner, like a violin string or a pendulum. Therefore, if we make a graph of a few complete cycles of motion showing the relative size of the cross section of light passing through the gate as in Figure 4, we will have a good idea of the light fluctuation reaching the mirror. It will increase and decrease in a sine-wave manner as shown.

**Beam Modulating**

From the mirror this light is projected onto the rotating cylinder carrying the picture to be transmitted. The light reaches the picture when focused to a point .01 inch square and is reflected from the picture back into the moving assembly and into a photo-cell (photo-cell to be explained later). The picture will reflect various amounts of light depending on whether it is black or white at that point or in proportion to any graduation between black and white as it passes under the light beam. Practically no light will be reflected from a black area while a large percentage of light will be reflected from a white area. In other words, shading in photographs will modulate the clear beam of light from the light source. In addition to this the amount of light will be proportional to the tone or grade between

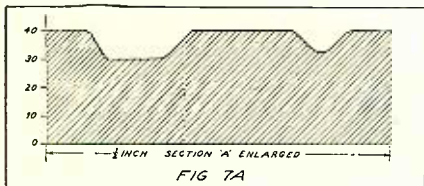

FIG 7A

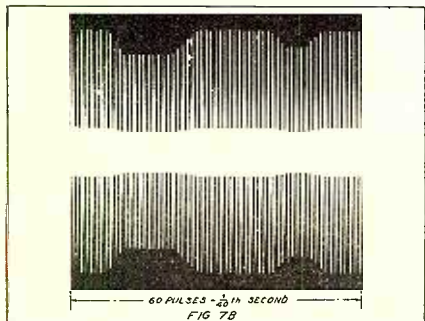

FIG 7B

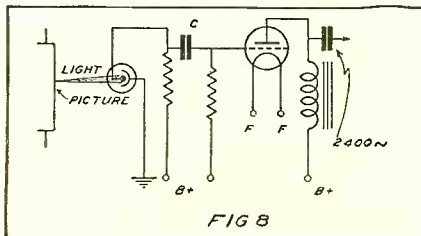

FIG 8

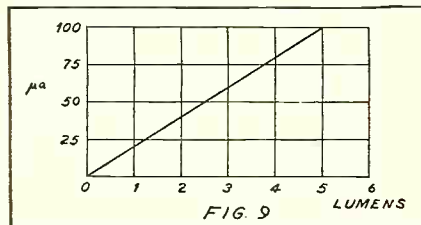

FIG 9



black and white of the picture. As the cylinder rotates the light traces a "helical" path on the picture as the unit carrying the light source and apparatus just described moves at the rate of .01 inch per revolution of the cylinder. The area traced by the light is much like the thread groove on the end of a pipe, one groove being directly adjacent to the next one.

### How Scanning Works

A study of the photograph in Figure 5 will show how this works. Note particularly the line through the photograph. This represents one tracing across the photograph. This one tracing or single beam of light as shown in Figure 5 (this beam of light would be reflected from the drum A in Figure 1) strikes the cathode of the photo-cell shown in Figure 1. The photo-cell changes the shadings of light intensities into electrical pulses which correspond exactly to the light intensities which strike the photo-cell. Thus intensities of light are changed into electrical pulses—and remember these represent reflections of one narrow strip of light from the photograph of Figure 5, which we are imagining is placed on drum A of Figure 1.

### Light Fluctuations

You are, no doubt, interested in the nature of the electrical pulses which represent the one narrow strip across the photograph of Figure 5. A graph of these pulses is shown in Figure 6.

Referring now to the photograph of Figure 5, from left to right, we first come to the wall in the picture which is quite light and may reflect about 80% of the light back onto the photo-cell. The modulated light fluctuates a trifle responding to the "grain" of the wall as seen. Then the picture turns with the side of the radio cabinet under the light. This is much darker and suddenly the percentage of reflected light reduces to below 40%. See the electrical equivalent in Figure 6.

### Picture Analyzing

Due to the "beading" and other decorative designs on the radio cabinet, this light as reflected varies some 10% in the region entering the cabinet side from the wall to the left and at other places. The "grain" of the cabinet top forms slight variations in the reflected light and so on.

In further pursuit of what happens in this instrument, let us take a small section (A of Figure 6) representing a length along the "scanning" or dissecting direction and give it further study. Let us say that the distance "A" is  $\frac{1}{2}$  inch long, and that the picture is moving under the light at the rate of 20 inches per second. To move distance "A" ( $\frac{1}{2}$  inch) then only requires  $\frac{1}{40}$ th of a second and

in this time the modulated light sends 60 "pulses" of light to the picture. If it produces 2400 pulses (cycles) in 1 second, in  $\frac{1}{40}$ th of a second it must send  $\frac{2400}{40}$  or 60 pulses of light to the picture to be reflected. These 60 pulses of reflected light on an enlarged scale would look graphically like Figure 7B. In Figure 7A we have duplicated section "A" on a much enlarged scale so that we can examine it more closely.

Figure 7B represents the actual amount of light falling on the photo-cell. We now must consider what this photo-cell is and what use it makes of those light pulses. The photo-cell used here is a type of vacuum tube having an anode element in the form of a circular ring and a cathode in the form of a circular disc. Of course, the construction of various types of photo-cells differ widely and some use a rod anode instead of the ring and a cylindrical cathode instead of a circular disc. Some even use a coating of metal condensed on the inner surface of the glass envelope as a cathode.

### How the Photo Cell Works

A d. c. voltage is impressed between the anode and cathode with, of course, cathode negative and anode positive and the reflected light from the picture is impressed on the cathode of the photo-cell. The cathode has been chemically prepared in such a way that it will discharge electrons when exposed to light and there will, of course, result a current of electrons to the anode.

Now the number of electrons liberated from the cathode depends very closely on the amount of light reaching it and since all liberated electrons are attracted by the anode having but one positive voltage value, the electron current depends on the light striking the cathode. Moreover the current is proportional to the amount of light reflected into the photo-cell.



FIGURE 5

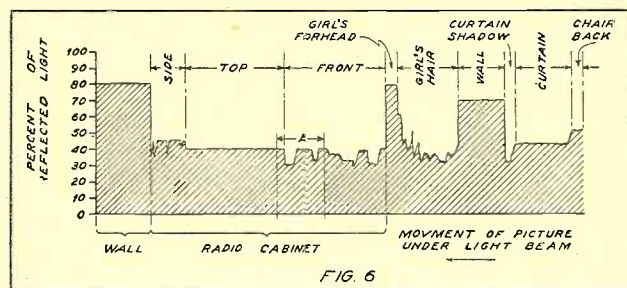

FIG. 6

### WHAT A "SCANNING" LINE REALLY MEANS

The photograph above, Figure 5, shows a scene being televised, the white line across the picture representing a scanning line. The diagram in Figure 6 shows how this line of light reflected from the scene will produce a varying electric current in accordance with light and dark portions of the scene.

The current flowing through the photo-cell circuit would, therefore, have 2400 pulses per second (if we employ the system of Figure 1) and the amplitude of the successive pulses would be modulated by the tone value of the original picture.

The photo-cell circuit is wired exactly as the plate circuit of an amplifying tube would be wired as in Figure 8. The effect of the light on the cathode is almost precisely like that of a control grid in a triode although the anode current here follows the light changes more accurately proportional than the plate current changes in a triode follow the grid voltage changes. What is equivalent to the Eg- $I_p$  curve in a triode, is the light— anode current. For a given anode voltage, 60 to 250 volts, depending on the cell, Figure 9 shows the perfectly linear relationship between the light intensity and the anode current.

### The Light Unit

To get a good idea of the size or magnitude of a "lumen" of light, one standard candle power requires very roughly 1 watt of power. Of course, if the power is used for lighting a filament type lamp, a good portion is converted into (Turn to page 423)



# The Single UNIT Servicer

Here the author describes a readily portable home-made service instrument which provides every kind of check or measurement encountered in normal service work

By Allen J. Loeb

MANY servicemen find themselves unable, because of limited incomes, to purchase the elaborate testing equipment featured in the new catalogs. Economy dictates the use of one set of equipment for both portable and shop use, and convenience suggests one instrument combining as many functions as possible. The analyzer described in this article can be built for about thirty dollars (current mail-order prices). It has been in daily use for the past six months, and with the exception of a small signal generator has been the only instrument in a small service shop. It is only necessary to add that all functions required in the servicing field have been performed with ease.

THE central feature of the analyzer is a Beede fan-type meter which is used in conjunction with a small copper-oxide rectifier for all readings. There are five voltage and three current ranges for either a.c. or d.c., high and low resistance ranges (with provision for testing resistances above 200,000 ohms using an external voltage source), and a capacity-impedance testing range which will be described in some detail below. This meter is also used as the indicating device in a sensitive tube short-checker which will reveal high or low resistance short circuits in any glass or metal tube.

### Fuse Protects Meter

Provision has been made for output readings using any a.c. range by the inclusion of a blocking condenser (C1) and an extra banana jack on the panel. Ranges are selected by means of an eleven position, double pole switch (Sw1) located directly below the meter in the center of the panel, and a meter reversing switch has been included. A single 1/100 ampere fuse provides adequate protection at all times.

tection at all times.

Perhaps the most distinctive element in the circuit is the numbering system used in set analysis. This is based on the system worked out by the R.M.A. for the octal base tubes and is readily adaptable to future developments. In it the number 1 always represents the ground or shield connection. In tubes that are not shielded, numbering starts with the first heater (or filament) connection which is number 2 and progresses clockwise around the socket when viewed from the underside. Thus the plate connection is number 3 in almost every case and the various grids in multi-element tubes are numbers 4, 5 and 6 depending on the number of prongs. The remaining heater connection, then, is number 7 and the cathode, number 8. Cap connections are designated as number 9 on any type tube. A glance at figure 2 will make this system quite clear to the reader.

### Simple to Operate

Two single-deck eleven-point switches (Sw4 and Sw5) are used to connect the meter for voltage readings between any two elements. These switches are provided with dial plates marked 1 to 11, the last two positions being left blank and held in reserve for later tube developments. In the circuit of each element there is a single pole—single throw toggle switch (Sw6 through Sw12) which is normally closed and opened only when taking current readings. Thus, to determine the plate current of a

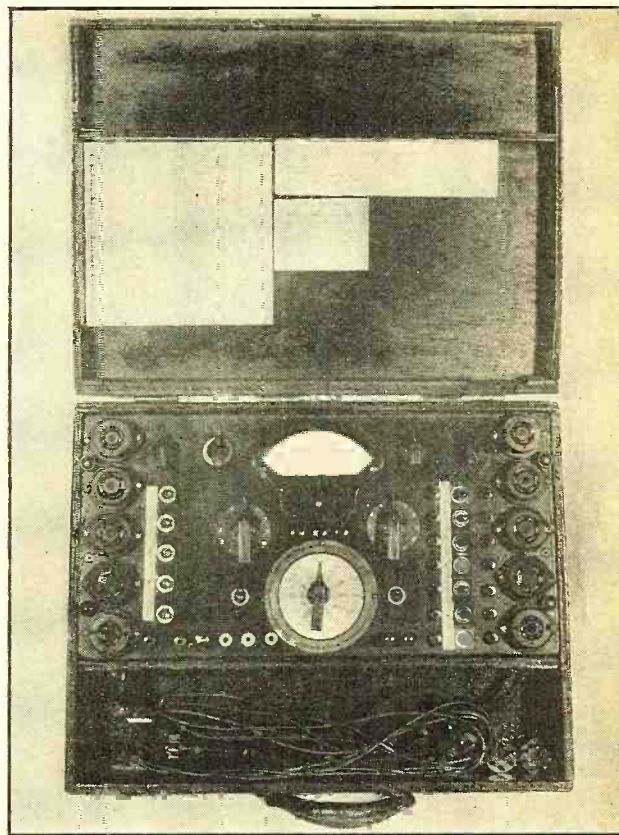

A PRACTICAL SERVICE TOOL

*Compact and really portable, this unit combines the functions of an analyzer, tube checker, multimeter and inductance capacity checker.*

tube in the analyzer socket it is only necessary to set both voltage switches (Sw4 and Sw5) to the number 3, or plate, position and open the toggle switch in that circuit.

### Provision for Noise Tests

Connected on either side of each toggle switch there is a banana jack, the pair of jacks providing easy access to any circuit whenever the switch is open. This makes it possible to introduce earphones or other external apparatus in series with any tube element. It may also be used to connect the meter for output measurements using the analyzer plug rather than external leads. This double row of jacks and toggle switches is located on the right side of the panel and the switches numbered in accordance with the system described above.

On the other side of the panel there are five double-pole double-throw switches (Sw13 through Sw17) located directly adjacent to the 4, 5, 6, 7 and 8 prong analyzer sockets and used for tube testing by the grid-swing method. These introduce six volts provided by a flashlight battery into any one of the five possible control-grid circuits and are likewise numbered in the system described. A chart (Figure 3) in the analyzer cover indicates the number of the plate and



control-grid connections for each type tube.

The short-checker used in this analyzer utilizes a very interesting principle. It is entirely independent of the rest of the unit except that it uses the 0-200,000 ohm scale of the meter as an indicating device. In order, therefore, to connect it for use, it is merely necessary to set the range switch to the high-ohm scale.

**Testing for "Shorts"**

This portion of the tester includes a row of five tube sockets mounted along the extreme right edge of the panel. Corresponding connections of these sockets are tied together and are separated from one another by 6 one-watt carbon resistors (R1 through R6) so that when a good tube is inserted in one of the sockets, its filament completes the circuit and connects a total resistance of 150,000 ohms across the meter. This, obviously, causes a very slight but noticeable deflection on the 0-200,000 ohm scale. Should there be an internal short-circuit in the tube, however, one or more of the carbon resistors will be shorted out of the circuit reducing the total resistance and increasing the deflection accordingly. Because of the relatively low resistance of a tube filament the meter reading for a good tube is always the same (around 150,000 ohms) and any reading that differs from this in the slightest degree indicates a short in the tube. Should the filament be open, of

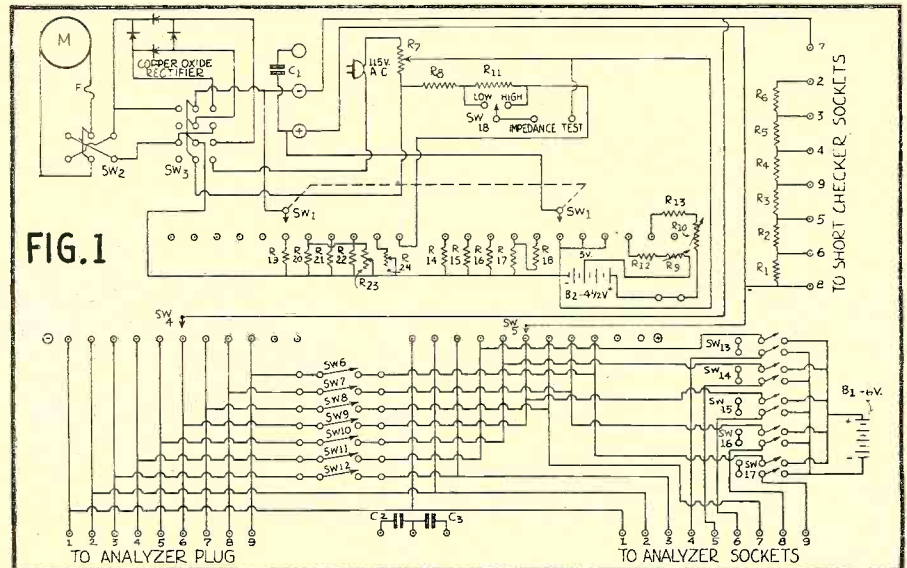

course, there will be no reading. In cases of intermittent short circuits it is sometimes necessary to pre-heat the tube before testing. This simple method is applied to practically all tubes in general use. The few types which have filament terminals at other positions may be tested by the ohmmeter outside the socket.

The capacity-impedance testing section of the instrument is placed in operation by connecting the external plug to a source of 110 volts a.c., throwing the a.c.-d.c. switch (Sw3) to the a.c. position (it will be noticed that this switch which is of the four-pole double-throw type uses the fourth pole to complete the connection from the line plug from the line plug when the switch is in the a.c. position thereby safeguarding the rectifier), and setting the range switch to the "cap-imp" position.

**Terminals**

Following the circuit, it will be seen that the tester utilizes a 5000 ohm wire-wound variable resistor (R7) as a zero adjuster in order to compensate for varying line voltages. A single-pole double-throw switch (Sw18) is used to change the range for high or low impedances and a

separate pair of jacks (green) is provided for the test leads. Leads for all other meter ranges terminate in a single pair of jacks located directly between the meter and the range switch in the center of the panel.

**Testing Impedances**

For high impedances such as those of condensers from .005 to 4 mfd. the impedance is placed in series with a 30,000 ohm resistor (R8) and the line voltage. The meter then acts as a high-resistance a.c. voltmeter and measures the voltage across the impedance under test. When the switch is in the "low impedance" position, the part being tested is placed across the line in series with a total resistance of 100,000 ohms. Then the meter acts as a low-resistance voltmeter. This range is useful for determining the impedances of chokes, transformer windings, etc. Of course, the meter can be calibrated in terms of impedances and capacities and charts or graphs made up.

**Substitution Test**

There is one other feature which, despite its great simplicity, is worthy of some comment. This is the condenser selector which consists of a one and an eight mfd. paper condenser and three yellow tip jacks on the lower left edge of the panel. Every service-man has wasted valuable time and even more valuable patience trying to find the place where slight additional by-passing was needed to eliminate a.c. hum. By having two standard size condensers connected to a trio of banana jacks on his analyzer panel, the serviceman can use his test leads to make substitutions and determine the source of

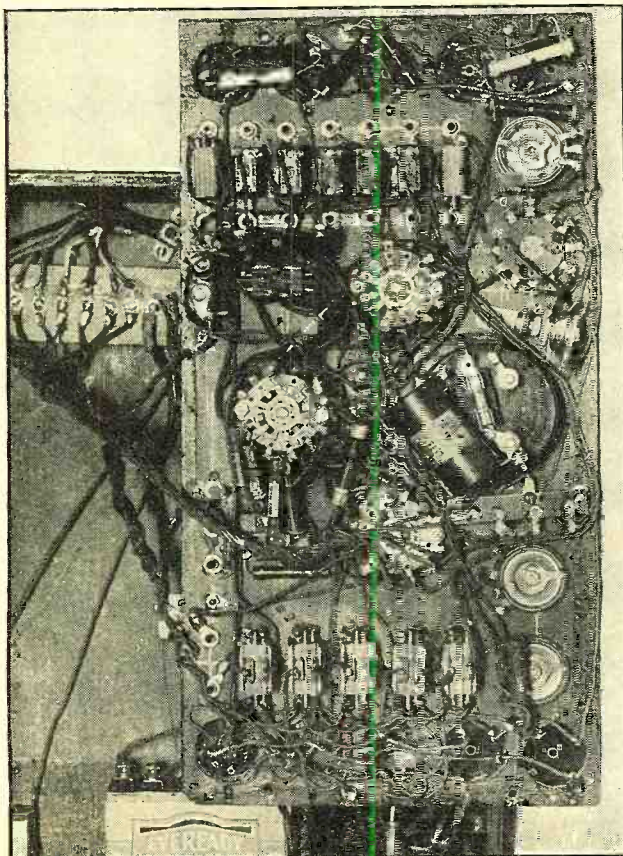

BEHIND THE SCENES

Here the layout and wiring are shown clearly, indicating, in conjunction with Figure 4, the exact placement of all switches and other components.



hum rapidly and with ease.

The layouts of parts on the 8 by 16 inch panel on which the analyzer is built has been fairly well covered in the preceding paragraphs. There are a few additional points, however.

The two variable resistors (R9 and R10) which are used as zero adjusters for the resistance reading scales are located on the upper edge of the panel between the tube sockets and the meter. R23 and R24 are mounted beneath the panel and are adjusted until the resistance scale reads exactly the value of a known resistance. The a.c.-d.c. switch and the impedance zero adjuster occupy the same positions on the opposite side. The meter-reversing switch (Sw2) and the impedance range switch are located respectively on the right and left sides of the range switch. There are three binding posts on the lower edge of the panel, two of which (normally connected by a jumper) are for an external voltage for resistance measurements above 200,000 ohms and the third, for a chassis lead to sets under test where this is desired.

It will be seen, therefore, that the layout of the panel is almost perfectly symmetrical. For the range switch, I used a large bar knob over a disk of white cardboard which is marked off to the various meter scales and held down by a 3-inch round escutcheon of the "airplane" dial type.

**The Cabinet**

The analyzer cabinet and panel are made of 3/8-inch plywood, assembled with 1-inch brads and glue. The box measures 12 3/4 by 16 by 2 5/8 inches. The cover is 1 1/4 inches deep. Specifications for the panel are given in Figure 4.

**List of Parts**

- C1, Paper condenser, 5 mfd., 600 v.
- C2, Paper condenser, 1 mfd., 600 v.
- C3, Electrolytic condenser, 8 mfd., 600 v.
- R1, R3, R4, R6, Carbon resistor, 20,000 ohms, 1 watt
- R2, R8, Carbon resistor, 30,000 ohms, 1 watt
- R5, Carbon resistor, 40,000 ohms, 1 watt
- R7, Potentiometer, 5,000 ohms
- R9, R22, Rheostat, 25 ohms
- R10, Rheostat, 750 ohms
- R11, Carbon resistor, 70,000 ohms
- R12, Wire-wound resistor, 15 ohms
- R13, Wire-wound resistor, 2,500 ohms
- R14, Carbon resistor, 5,000 ohms
- R15, Wire-wound resistor, 10,000 ohms
- R16, Carbon resistor, 50,000 ohms
- R17, Carbon resistor, 250,000 ohms

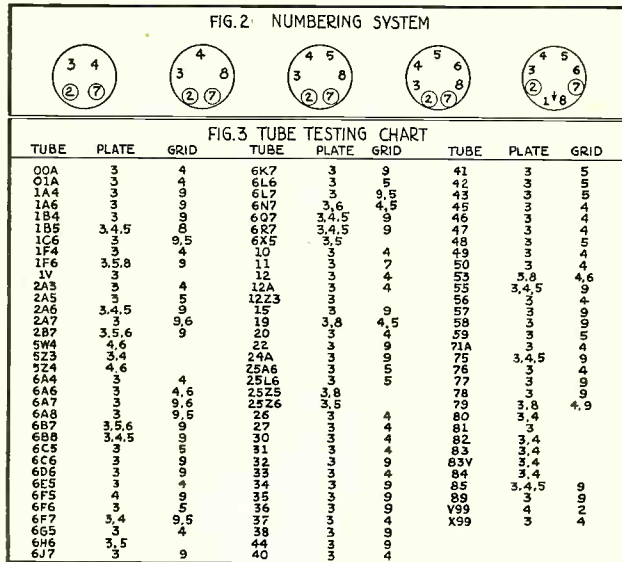

- R18, Carbon resistor, 500,000 ohms
- R19, Radio City, 5 mil. meter shunt
- R20, Radio City, 50 mil. meter shunt
- R21, Radio City, 500 mil. meter shunt
- R23, Rheostat, 30 ohms
- R24, Rheostat, 400 ohms
- Sw1, 2-deck, 11-point switch
- Sw2, Sw13, Sw14, Sw15, Sw16, Sw17, Double-pole, double-throw toggle switch
- Sw3, Eby 4-pole double-throw switch
- Sw4, Sw5, 1 deck, 11 point switch
- Sw6, Sw7, Sw8, Sw9, Sw10, Sw11, Sw12, single-pole, single-throw toggle switches
- Sw18, Single-pole, double-throw toggle switch
- B1, B2, 6-volt dry cell battery
- 2 8-prong tube sockets
- 2 7-prong tube sockets
- 2 6-prong tube sockets
- 2 5-prong tube sockets
- 2 4-prong tube sockets
- 1 8-prong analyzer plug
- 1 9-wire cable
- 1 set of plug adapters
- 2 banana jacks (green)
- 3 banana jacks (yellow)
- 8 banana jacks (red)
- 9 banana jacks (black)
- 2 small tip jacks
- 3 binding posts
- 1 2-wire plug connector
- knobs, dial plates, etc.
- Beede O-1 mil. fan-type meter
- Copper-oxide rectifier
- 1/100-ampere fuse and holder

The parts listed above represent the actual components employed in the instrument described, with the exception of C3, which is a paper-type condenser instead of the electrolytic specified. Some builders may

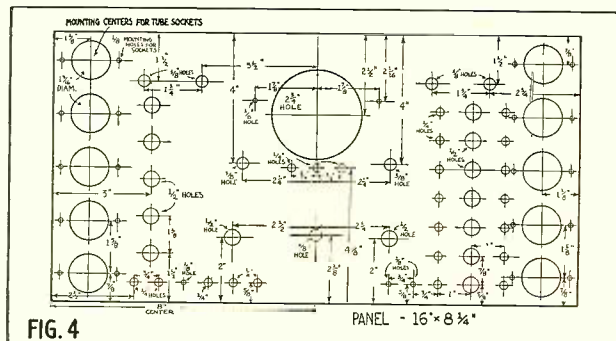

have difficulty in obtaining 600 volt paper condensers of sufficiently small dimensions to fit within the cabinet. The required 8 mfd. may be made up, of course, by using several 1 or 2 mfd. paper condensers in parallel. If the electrolytic type is employed, care should be taken to observe the proper polarity of its terminals when connecting it across the circuit under test.

Those who have on hand other type meters which they wish to adapt to this circuit may do so providing the values of the resistances in the ohmmeter circuit are adjusted to match the scale employed on the meter selected. This may be done by

adjusting the series resistances for each range until the meter gives full scale deflection with the test leads shorted and half-scale reading when the leads are connected across a resistance of a value corresponding to the half-scale ohmmeter calibration point.

For other type meters, of course, the shunts specified will not be suitable unless the internal resistance of the meter is the same as that of the one specified in the article. The same multipliers may be employed, however. For greater precision, accurate wire-wound multipliers are preferable but the cost of the instrument will then be appreciably increased.

**R S A Growing Fast**

Chicago, Ill.—The recent announcement of the formation of the Radio Servicemen of America brought a large number of applications for membership from existing local groups of servicemen, including such prominent organizations as those in Cleveland, Chicago, Birminghamton, Denver, and Duluth.

Servicemen interested in joining this national organization are invited to write Radio Servicemen of America, Room 1533, 304 S. Dearborn Street, Chicago, Illinois, for an application blank and information on how to become a member. Groups are invited to inquire concerning a charter from this national organization of, by, and for radio servicemen.

**PANEL DRILLING PLAN**  
 Since a plywood panel is employed for this instrument, the large holes shown are easy to drill. Adequate spacing makes for simplicity in assembly and wiring.





Figure 2. An English shop devoted exclusively to radio service—largely for the trade.

### THE RADIO STORE AT XMAS

THE fact that more buying is done during the week immediately preceding Xmas than during any other six-day period in the year does not mean that it is any easier to secure one's own share of business. As a matter of fact, competition is particularly keen over the yuletide, and it is only by good salesmanship and all the trimmings that full advantage can be taken of the festive Buying Spirit. The word "trimmings" can be taken literally, as we refer largely to store and window displays.

YOUR distributor and set and tube manufacturers should be given every opportunity to cooperate with you in preparing attractive displays. Many of them have prepared special holiday material and have sent you literature describing the same. Make a generous selection of cartons, backgrounds, manikins, streamers, etc., etc. that will fit in with your general scheme of things. Such display material—

#### Plus a Bit of Originality

will do much to attract customers into your store and shop. Originality and the personal touch are highly desirable to individualize your establishment among others that may be using similar commercial material. You needn't be an interior decorator to prepare an attractive window. A bit of common sense and a few rolls of crêpe paper are the essentials.

The Xmas colors are red, green and white. Snow effects are readily created with cotton and common salt.

Figure 1. A very simple filter arrangement that will eliminate the interference from thermal controlled blinkers.

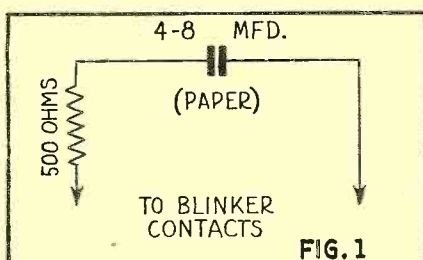

Snow on a Xmas tree or the cap and shoulders of a Santa Claus can be simulated with flake camphor or artificial snow which can be obtained in the five-and-ten cent stores.

It is not enough merely to have sets on display. Everyone else in the business will be doing just that. Obtain ten yards or so of wide red ribbon. "Tie-up" a few receivers in gift fashion, running the ribbon diagonally across the front of the cabinet. A bit of rubber cement will hold it in place and do no damage to the cabinet. Attach large Xmas cards to the ribbons—"Merry Xmas"—"Merry Xmas to The Family"—"Merry Xmas to All!" A more pointed sales suggestion might be attached to say a small table model and read "Merry Xmas to Dad—for his den!"

Make up some cards in easel form, and stand these on several receivers, on the counters and in your show window. Suggested wording is—"OUR XMAS PRESENT TO YOU"—One year's free service on all sets bought before the first of the year!

#### Sidelines

Consistent with the buying boom, sideline sales run into large figures during the holiday season. A questionnaire recently sent to servicemen running small stores shows that *toys are the most profitable sideline with electric trains heading the list!* Biggest sales however are *Xmas tree lighting outfits and replacement bulbs.* *Electric toasters and waffle irons* are next in order. *Cameras—still and movie—and projectors* selling for under \$20.00 also sell well just before Xmas and during Xmas week. Other more or less standard sidelines, such as electric irons, electric curling irons, flashlights, refrigerators and washing machines do not sell as well at this time and it is desirable that they be temporarily relegated to the background and the space used for display of radio and more appropriate Xmas sidelines.

#### Animation

Animation contributes much to any display, and Xmas material offers

# Service-

### This Month:

A Xmas Set-up . . . Service Shops . . . The Floor Plan . . . Common Ailment . . . Servicing with the Oscilloscope . . . **SERVICING:** Browning, Belmont, Wings, Bosch, Silvertone, Majestic and Arvin

considerable opportunity for inexpensive animation. Red, green and amber lights can be blinked with low cost thermal blinkers. If a Xmas tree forms a part of the display, the lights on the tree can be similarly blinked. (If you are running set demonstrations and the blinker causes interference, try the simple filter shown in Figure 1. However, the blinker will seldom kick up a racket if a good noise reduction antenna is used in the store—as should always be done.)

About the most effective bit of animation is an electric train. Nothing will more quickly gather a crowd— young and old, male and female— and hold it! The display is really double-barreled in that it also forms a very profitable item for sale. The same applies to any other electrically operated toys.

Merry Xmas—and a profitable new year!

### THE MONTH'S SERVICE SHOP

FOR the second time within a few months England is represented in this department—and incidentally from the same city of Manchester. Thomas A. Greenhalgh, Ltd., sends us the photograph of Figure 2 which speaks quite adequately for itself. Writes Mr. Greenhalgh—

"As our work is almost entirely done for the trade, a most exacting standard has to be maintained—such a standard that we cannot devote our time to anything other than service, and we claim to be the only firm operating in this country solely on radio repairs. To insure the high standard

Figure 4. Oscillogram of faulty radio with gain full on.

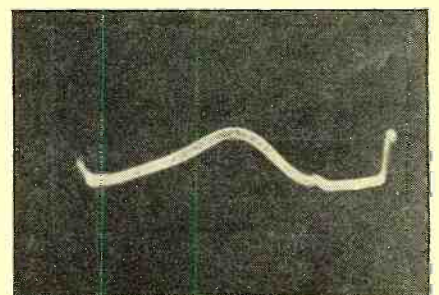



# Sales

By Zeh Bouck  
Service Editor

of work required, we make it a rule that no engineer can work longer than a period of 44 hours weekly. We found from experience that when an engineer is overworked he suffers from loss of interest in his work, and the standard deteriorates accordingly. In order to stock efficiently the huge number of American, English and continental valves (tubes) required for service work, we have had to arrange these in special trays on a separate portion of our premises, so that it is only a matter of seconds for an engineer to pick out the correct replacement valve. We are now in the process of installing sound and static-proof test rooms so that every possible test can be made to insure satisfaction."

Figure 3 shows the advertisement appearing on the reverse side of Figure 2.

### The Floor Plan

Many servicemen and small dealers obtain radios for sale on what is known as a "floor plan." Most of the well-known makes can be obtained in this way, and distributors will furnish full information. Usually the serviceman or dealer pays 10-percent cash for the receivers—paying in full as they are sold. At the end of three

Figure 6. After realignment—with the receiver in perfect condition. Ordinarily the receiver would have been returned to the customer in the condition that made the curve shown in Figure 5. The customer can thank the oscilloscope!

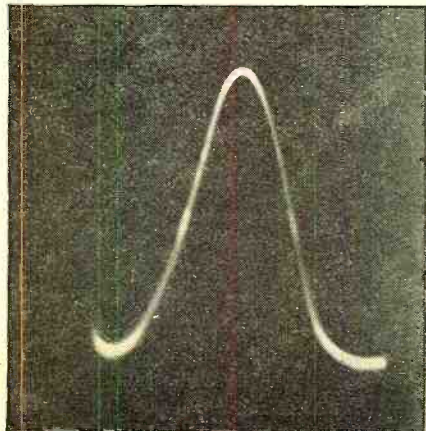

Our SOLE job is the Repair of Faulty Radio Receivers.

We collect your receiver, furnish a FREE written Estimate for a perfect job and return with speed.

Your every possible satisfaction will be ensured, and a trial job will prove it.

RING BLA 9537

CALL and see our MODEL WORKSHOPS.

Cromford House  
Cromford Court  
Market Street  
MANCHESTER 4

THOMAS A. GREENHALGH LTD.

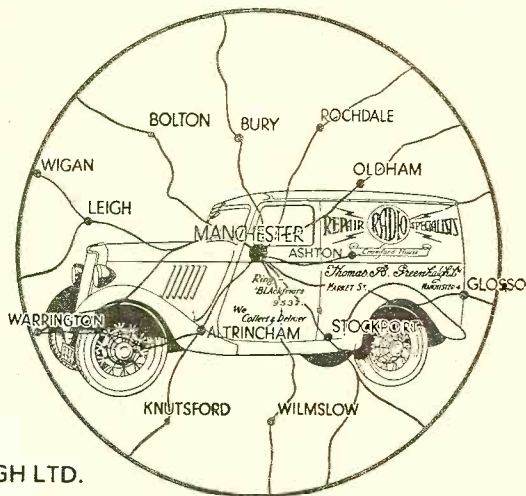

### HOW ONE SERVICE ORGANIZATION GETS BUSINESS

Figure 3. The reverse side of the photograph of Figure 2. The two sides form an excellent advertisement. Slipped in the mail box or under the door, this card always makes a good impression and "makes service sales."

months if not sold, he pays another 10 percent. At the end of six months he pays a third 10-percent, and 10-percent monthly after that until the receivers are sold or the full price paid up. This makes it possible for the small store to show a presentable line of receivers without entailing a large financial investment. However, the plan has its disadvantages, and the serviceman should work for a reasonable contract. The receivers are delivered for "floor use" only—hence the system is known as the floor plan. This means that the receivers cannot be removed from the dealer's floor—and a representative of the company comes around every few days (usually at unexpected times) to check up and see that all the sets are on the floor. Should one of them be missing, the dealer must pay in full immediately for that receiver. This means that a set cannot be removed to a prospect's home for a demonstration—which sometimes kills a sale. Needless to say most dealers disregard these conditions at their own risk—and occasionally get stuck. We suggest that the serviceman, before signing on the dotted

line, negotiate for a half-way reasonable floor plan.

### THE SERVICE BENCH

R. O. L., of New Brunswick, Ga., writes in and reports trouble with a—

#### Browning—35

"The receiver is dead, and one can usually smell smoke after attempted operation for a minute or so. The audio is okay as can be readily determined by touching the grid cap of the second detector tube. I have had several of these sets in with the same trouble which is due to a shorted .05 mfd. by-pass condenser from the plate supply to the cathode of the first detector. This puts a high potential across the first-detector cathode resistor (350 ohms) which will burn this out if the current is left on very long. It is a good idea to check this resistor when replacing the condenser."

#### Common Ailment

"I have found the trouble to be described common to many receivers. It was discovered accidentally when checking for a short-circuited condenser by the resistance method with

(Turn to page 422)

Figure 5. Normal gain and with the main trouble removed.

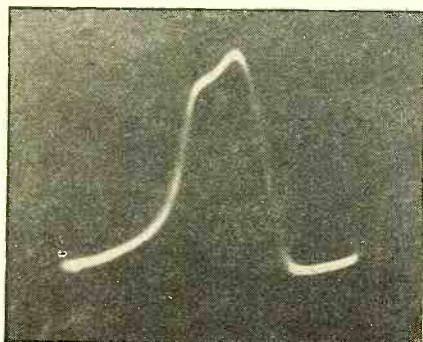

### Servicemen! Dealers!

HAVE you a well-equipped shop, neatly and efficiently laid out? Or an attractive and effective Window Display, Sales Counter, Demonstration Room, or Service Bench? If so, send in a photo, with a short description, for publication. After using it, you can have the cut, free of charge.

Here is a chance to obtain an expensive cut, gratis, suitable for any literature or newspaper advertising you have in mind.

Send photos and captions to the Service Editor, RADIO NEWS, 461 Eighth Avenue, New York City.



# *A 100,000 Ohms-per-Volt*

# D. C. VOLTMETER

## *That You Can Build*

**O**FTEN it becomes necessary to measure voltages in high resistance d.c. circuits without upsetting the conditions in the circuit. Such, for instance, as in checking the voltages in resistance-coupled amplifiers, a.v.c. and a.f.c. systems. This requires a voltmeter with an extremely high "ohms per volt" rating, which places a negligible load on the circuit. Such an instrument is the vacuum-tube voltmeter.

The unit described here is a vacuum-tube voltmeter for d.c. only. It employs one type 30 tube, is battery operated and does not require calibration. It provides 8 ranges. Four of them present infinite impedance; 0-5, 10, 50, 100 volts. The other four, 0-25, 50, 250, 500 volts, present impedance of 50 megohms. One zero adjustment is sufficient for use throughout any one range. The accuracy of the instrument is approximately 3% of full scale deflection when adjusted by comparison with an accurate standard.

### Linear Scale

In the design of a vacuum-tube voltmeter for d.c. rectification is not desired and the tube must be operated on the straight part of its characteristic, as a class A amplifier. In this particular application it was desired to have a wide range and to make the range linear. This is accomplished by placing a load resistance in the cathode circuit (or B-lead), making the tube degenerative. Such a scheme straightens the characteristic of the circuit, and when a fairly straight portion of the characteristic has been picked in the first place, there is no difficulty in making the meter scale linear. The circuit is shown in Figure 1. The different ranges are obtained by changing the bias resistor. The steady plate current is bucked out by means of an opposing voltage obtained from the filament battery through potentiometer R13, which provides the zero adjustment and the resistors, R8, R9, R10, R11. By proper selection of these resistors and

**T**HE simple yet exceedingly practical voltmeter described here permits accurate measurements in critical circuits and enables tracking down obscure troubles in high-resistance circuits which otherwise are almost impossible to locate.

By Gerard J. Kelly

the bias resistors any desired range can be covered. Both groups are switched by a common two-deck switch. Zero adjustment must, of course, be made with a closed grid circuit, which necessitates the inclusion of switch S3. The maximum voltage that can be measured by the above described system must necessarily be lower than the B battery voltage or cause grid current to flow.

In order to multiply the ranges,

### AS NEAT AS IT IS PRACTICAL

*Easily portable and completely self-contained, this instrument finds a wide range of utility in the shop and laboratory.*

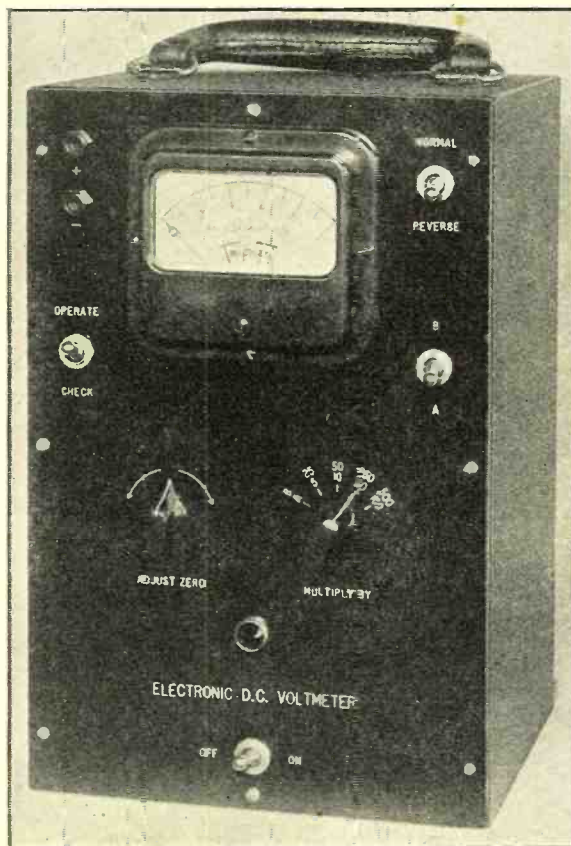

the voltage divider R1-R2-R3 is used which places 50 megohms across the input terminals and connects the grid of the tube to the 10-megohm tap. Thus all ranges are multiplied by 5. Any other multiplication of ranges can be obtained by suitably choosing the values of dividing resistors.

Switch S2 cuts in the voltage divider in position B while the input terminals connect directly to grid when S2 is in position A. A reversing switch, S1, is included.

The accuracy of the instrument depends on: 1, the accuracy of the calibrating means; 2, the accuracy of the indicating meter; 3, the value of the bias resistor and possibility of securing the exact value of resistance. If care is taken in adjustment it is possible to make this instrument accurate to within 3% of full scale reading for each range.

Variations due to the running down of batteries are mostly compensated for by means of the zero corrector but there is a possible maximum error of 1/2% introduced by A battery voltage variations if the unit is adjusted initially at a filament voltage which is the average of the useful life of the battery. The A battery should be replaced when the voltage on the filament has dropped to 1.2 volt while the B battery should not be permitted to fall below 110 volts. The plate current drain on the various ranges in the "check" position is: 2.25 ma. for the 5 volt range, 1.1 ma. for the 10 volt range; 0.27 ma. for the 50 volt range and 0.14 ma. for the 100 volt range. At full scale reading the plate current is 1 ma. more than the above values.

### Easily Built

The construction is very simple and is well illustrated by the photographs. A standard Par-Metal cabinet is used, but with the front replaced by a bakelite panel. All the bias resistors, the filament resistor and the tube are mounted on a bakelite sub-panel which in turn is mounted on posts.



These posts are held in place by the meter mounting screws. The bias resistors are of the adjustable type and are so arranged that the slides are easily accessible. The socket must be positioned so as to have the two filament holes vertically above each other in order to prevent the filament from sagging against the grid when the tube is horizontal.

The zero correcting resistors R8, R9, R10, and R11, the series resistor for the pilot lamp and the multipliers for the B range are mounted on a second strip of bakelite over the switch S5. These resistors consist of several of the carbon type in series and were selected from a generous supply so as to obtain the odd values required.

An accurate ohmmeter should be used for their selection. If a large supply of such resistors is not available it is better to employ the adjustable type of resistor (type ABA of IRC) and set them for the correct value indicated in the parts list.

The batteries are mounted in the case as shown in the photograph, use being made of fiber paper between the batteries. A block of wood is wedged between the upper wall of the case and the battery to prevent them from moving (not shown in the photograph.)

No part of the circuit is connected to the case but B- can be "grounded" to the case through a condenser, shown dotted in Figure 1.

### Initial Adjustments

A good grade of hook-up wire should be used to keep the input resistance high and prevent moisture absorption. The values of the resistors given in this article apply to a unit employing the type 421 Triplet 0-1 ma. meter and an RCA type 30 tube. Equivalent material of different manufacturers may require slight changes in the values.

To adjust the instrument, set it up with its batteries outside the case. Adjust the filament voltage to 1.6 volts for the duration of this process. Use an extra resistor in series with R14 temporarily if necessary. Next obtain a source of voltage variable from 1 to 100 volts; this can consist of B batteries and a high-resistance potentiometer. The most accurate voltmeter available should then be connected across the supply and the volt-

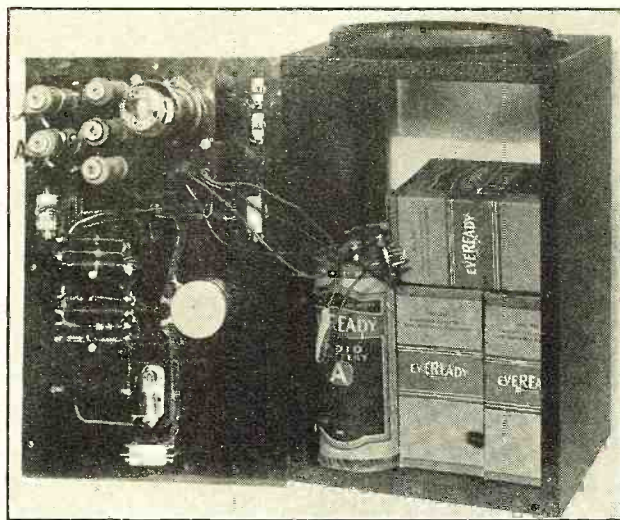

THE INSIDE ASSEMBLY

All parts are mounted on the Bakelite front panel. The case serves as a container for the batteries.

tage adjusted to 5 volts with the voltage supply connected to the input terminals of the unit and the switch S3 in the A position. Keeping S3 on "check" adjust R8 (if it is variable, otherwise R13) until the meter reads zero. Then throwing S3 to "operate", thereby placing exactly 5 volts on the grid, adjust R4, until the meter reads exactly full scale. The last adjustment has reacted on the first, so again set S3 to "check", adjust R8 (or R13) for zero, again set S3 to "operate" and adjust R4 for full scale deflection. This should be repeated until the meter reads zero in the "check" position and full scale in the operate position without having to make any more adjustments. Intermediate checks can be made at 0.1 full scale reading, etc., by comparison with the standard voltmeter. The adjustment is now complete for this range.

### Using the Voltmeter

Next adjust the voltage supply to 10 volts, set S5 for the 10 volt range and adjust R5, R9 (or R13) for this range. Repeat the same procedure

for other ranges. The accuracy of the B ranges can be checked by comparing a 100 volt reading on the A range with that on the B 500 volt range. If possible resistors should be selected so as to make the readings of the B range correct.

The values given in the parts list are those of the final adjustment of the model unit.

In order to prevent damage to the d.c. voltmeter, one should always start with the highest voltage range when measuring an unknown potential. Also, an open grid circuit causes the grid to assume a negative charge which will make the meter go off scale on the lowest range. Therefore, before making a measurement, adjust R13 with S3 in the "check" position, with S5 on the 500 volt range and S2 on B. Then connect the circuit to be checked to the input terminals. Now move S3 to "operate" and read the voltage. Lower ranges can then be used if the voltage proves to be low. In all cases, the circuit to be measured, when A scales are used, should be connected to the unit before S3 is set to "operate" and it should have a complete d.c. path. When a very high resistance is introduced in the circuit under measurement, the minute ionic currents, due to gas inside the tube, will cause a voltage drop across this resistance introducing an error. This error reaches a magnitude of 5 percent when the external resistance is 50 megohms. For ordinary values it is negligible.

### For D. C. Only

This voltmeter is not suitable for a.c. measurements. When a.c. is superimposed on d.c. the instrument will read the d.c. component only, with an error which reaches a maximum of 2 percent when the peak voltage of the a.c. component equals the d.c. component. If the a.c. is larger than the applied d.c. voltage readings are unreliable.

### Parts List

- R1, R2—IRC carbon resistors, type BT1, 20 megs., 1 watt
- R3—IRC carbon resistor, type BT1, 10 megs., 1 watt
- R4—IRC wire-wound resistor, type ABA, 4000 ohms., 10 watts, set at 3200 ohms.
- R5—IRC wire-wound resistor, type ABA, 10,000 ohms., 10 watts, set at 7400 ohms.

(Turn to page 431)

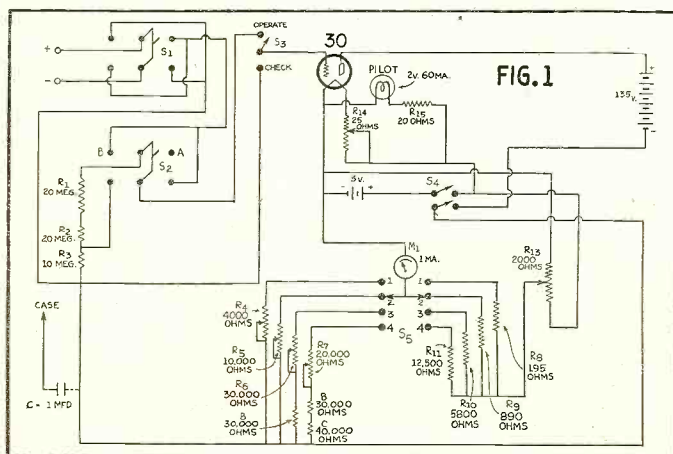



# Important Points in Designing a SET TESTER

THE design of service test equipment, as far as the electrical circuits are concerned, follows regular formulas. In this article we describe a modern set tester and endeavor to show how each of the circuits were calculated.

In Figure 1, this set tester is shown. Antique bronze panel, golden oak carrying case and brown moulded bakelite panel parts form a combination both pleasing to the eye and intensely practical—well able to stand the everyday bumps and knocks of service use.

The new Supreme-Westinghouse meter is used in this model with a choice of either a 1 ma. (1000 ohms-per-volt) or a 40 microampere (25,000 ohms-per-volt) movement.

## Single Control

Only one master selector switch is used so that all functions and ranges are available at once by a mere twist of the wrist. All functions and ranges, except those associated with the ohmmeter, are terminated at the pin jacks on the left side of the panel, whereas the ohmmeter functions and ranges terminate at the pin jacks on the right side of panel, with the "megohms" pin jack between the two rotary controls.

Two additional toggle switches are provided. The one on the left side of the panel is thrown to either the ac. or the dc. position, depending upon the functions desired. The right toggle switch is a momentary type normally being in the down position. This switch is used in the ac. voltage and megohms circuits.

Having described the panel appearance of this set tester, let us examine the complete schematic circuit diagram (Fig. 2). This is for the 1 ma. meter movement and shows a total of 20 functions and ranges as follows: 4 ac. voltage ranges of 0/7/140/350/1400; 4 dc. voltage ranges of 0/7/140/350/1400; 4 output ranges of 0/7/140/350/1400 ac. volts; 3 dc. ma. ranges of 0/7/35/140; 3 resistance ranges of 0/200/2,000/20,000 ohms and 2-megohm ranges of 0/2/20 megohms.

## Rugged Meter

In Figure 3 we note a reproduction of the meter's scales. It will be readily apparent that only 4 basic

THE author, as Service Engineer of the Supreme Instruments Corporation, is well qualified to discuss the problems and point out the solutions in set-tester design. Servicemen, who regularly use such apparatus, will find many points in this discussion that will be helpful toward a complete understanding of its use. Others, who would want to build a set tester, will glean useful information that will help them in their own designs.

## By Sam'l C. Milbourne

### Part One

scales take care of all functions and ranges. Thus, ac. voltages do not require "zig-zag" or "off-set" non-linear scales, but—due to the patented Iso-grad circuit, these indications are perfectly linear.

It may also be noted that the ohmmeter scale has been so designed that all ranges are decimal ratios of the basic 0/2000 scale. For instance, indications for the 0/200 range are divided by 10, indications for the 0/2000 range are read direct, for the 0/20,000 scale multiplied by 10, etc. Due to the excellent scale distribution, the first indication on the low ohms range is 0.1 ohms and 3.5 ohms is *center scale!* This gives an extremely satisfactory range for testing low resistances such as encountered in voice coils, rf. coils, rf. chokes, etc.

The 0/7/35/140 basic voltage and milliampere scales are used in a simi-

lar manner. For the 0/350 range, the indication is read on the 0/35 scale and multiplied by 10; for the 0/1400 range, the indication is read on the 0/1400 scale and multiplied by 10.

Just a word about the meter movement as this is the foundation upon which all metered instruments are built. This rugged meter utilizes a sword type pointer which combines readability with strength. The meter movement proper is of the high torque variety, heavily damped and utilizing a hi-permeability magnet with welded pole tips.

## Accuracy Assured

Any meter movement will have some value of internal resistance and this will vary between individual units of like model and sensitivity. The 1 ma. movement used in this Set Tester has an approximate internal resistance of 90 ohms. So that all values of resistors used in functional circuits can be pre-determined, the internal resistance of the meter is combined with a special, wire wound, external resistor to a total value of exactly 300 ohms. In other words, if the meter's internal resistance is 95 ohms, the external resistance will be wound to an accurate value of 205 ohms so that, in combination, they will total 300 ohms. This is shown in Figure 4.

To help in the calculation of the various circuits, sectional schematic diagrams are given showing just the parts used for that particular function.

Figure 5 shows the sectional dc. voltage circuit. The "ac.-dc." toggle switch is thrown to the "dc." position and the master selector switch rotated to the range desired.

Now, whether the meter movement is calibrated in terms of volts, milliamperes, microfarads, decibels, etc. the movement always measures current. When used as a voltmeter, it is connected in series with an external high resistance of a pre-computed value and when used as a milliammeter it is connected in parallel with some pre-computed relatively low value resistor.

When a meter has a full-scale reading of 1.0 milliampere, the required series resistance necessary to make the meter read 1 volt at full

## A MODERN INSTRUMENT OF MANY USES

Figure 1: The set tester, with its cover removed to show the control panel, including meter, the master selector switch, the zero adjuster, and other controls. At the top is a compartment for the test leads.





scale deflection is 1000 ohms. This is its "ohms-per-volt" designation and is equal to the total internal resistance of the meter plus the external series resistor, or  $R_T$ , divided by the required maximum voltage for full scale deflection. In other words:

$$R_{PV} = \frac{R_T}{E_T} = \frac{300}{.3} = 1000 \text{ ohms-per-volt}$$

as we know the "R<sub>PV</sub>" value, the "R<sub>T</sub>" value for any stated "E<sub>T</sub>" will be  $R_T/R_{PV}=E_T$  which is the same as saying, in this case, that the total circuit resistance necessary for any definite range is equal to the product of 1000 times the range's full scale value.

**Applying the Formula**

Let's see how this works out in practice.

For the 7 volt range, we would require a total of 1000 times 7 or 7000 ohms. The internal meter resistance plus its external resistor equals 300 ohms so we only have to add 6700 ohms and we have our total of 7000 ohms. For the 140-volt range, we require 140,000 ohms. We have 7000 ohms so if we add 133,000 ohms we have our correct total series resistance. For the 350-volt range we add 210,000 ohms—140,000 ohms leaving a balance required of 210,000 ohms to make up our required 350,000 ohm total. For the 1400 volt range, we require 1,400,000 ohms. We have 350,000 ohms and therefore require the difference or 1,050,000 ohms.

**The Current Ranges**

When using a meter to measure accurately the current passing through any circuit, all the current must pass through the meter or be by-passed by the use of a "shunt" as shown in Figure 6. Inasmuch as a 1 ma. meter movement requires but 1 ma. of current to indicate full scale, if higher current values are measured, the excess current must be shunted around the meter. For the 7-ma. range, we will want 1 ma. flowing through the meter and 6 ma. through the shunt. As the total meter resistance is 300 ohms and we want the shunt to carry 6 times the current passing through the meter, we will make the shunt value 1/6 the total resistance of 300 ohms or 50 ohms. For the higher current measuring ranges, the 50-ohm shunt resistor is tapped in two places forming what is known as a "ring type" shunt, the ring resistance being a total of all resistances (300 ohms meter resistance plus 40 ohms plus 7.5 ohms (Turn to page 446)

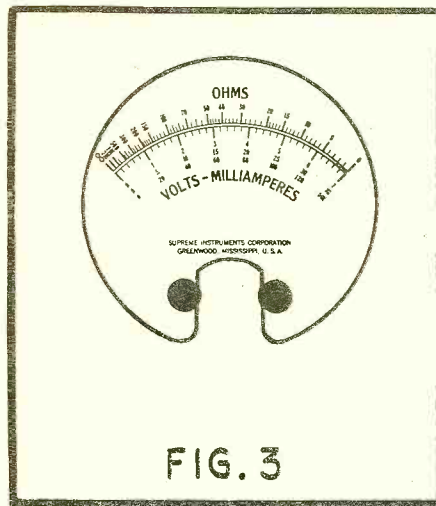

FIG. 3

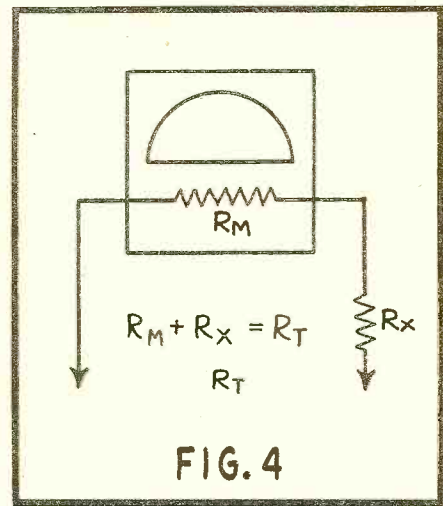
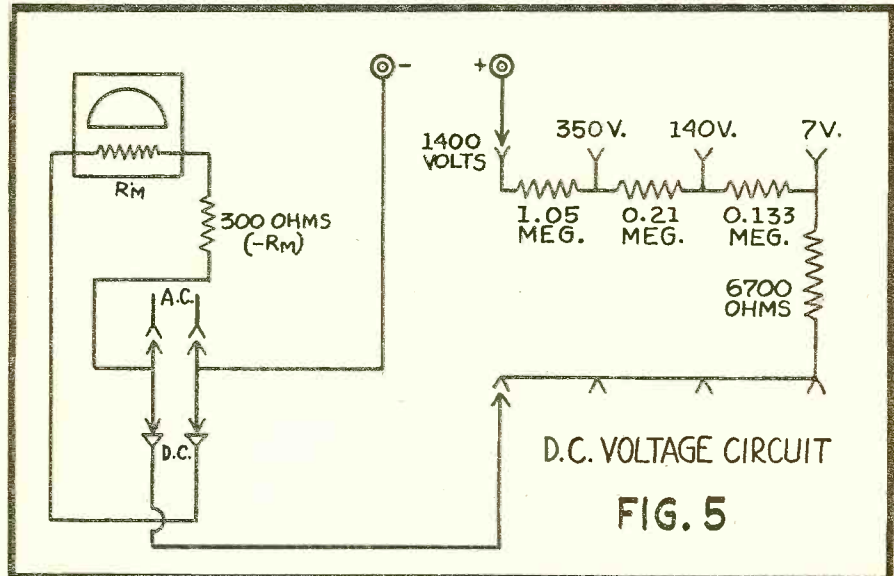

FIG. 4



D.C. VOLTAGE CIRCUIT  
FIG. 5

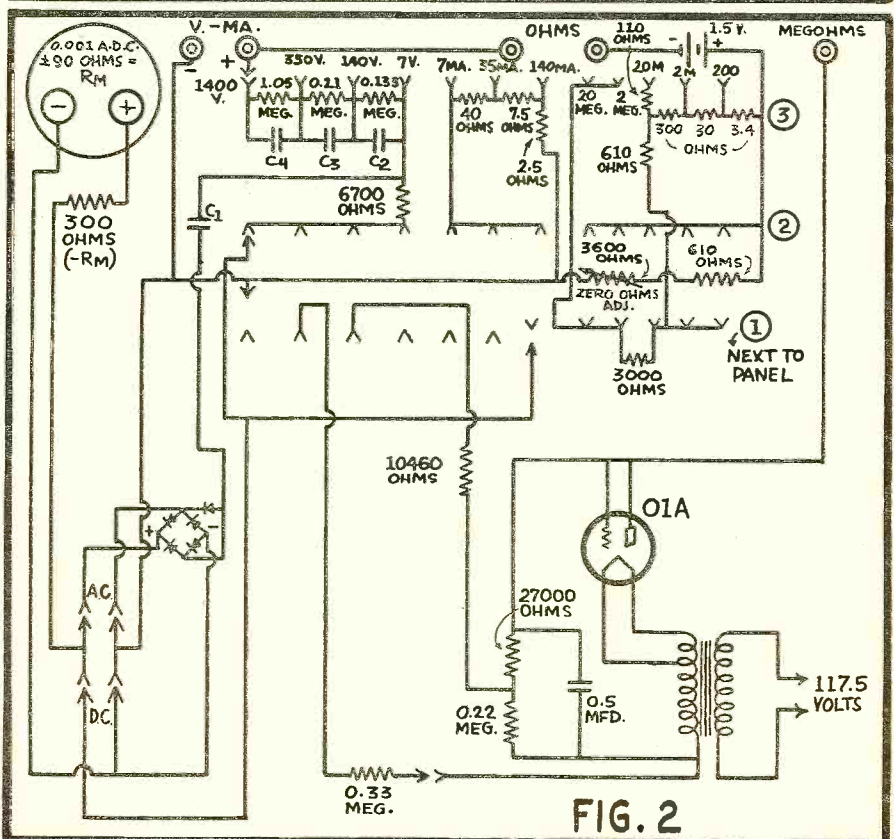

FIG. 2



# See Them AT YOUR DEALER'S (New Radio Products)

## For Servicemen and Dealers

The General Cement Mfg. Company just brought out a new radio cabinet and refrigerator patch kit. It is a very handy kit for filling in deep nicks and scratches in radio cabinets and it is equally applicable for patching plastic and bakelite cabinets and white refrigerators. It consists of six shellac sticks in light and dark shades of walnut, oak, also black and white, an alcohol lamp, a spatula, steel wool, sand paper, and a wiping cloth.

## New Vibrator Power Supply

In response to the insistent demand for a vibrator power supply suitable for use on airplanes, busses and motor boats for powering radio transmitters, receivers, and direction-finding equipment, P. R. Mallory and Company have announced their new "Vibrapak" model VP-G556, designed to operate from a 12-volt storage battery. This new unit delivers 300 volts at 100 ma. with three lower voltage outputs of 275, 250, and 225 volts instantly available at the turn of a switch. A synchronous vibrator is employed.

## Double-Purpose Radio

The Sentinel "Rad-O-Fone" is a complete communication system with extension speaker, and as illustrated in the accompanying photograph is employed in conjunction with a



standard Sentinel radio receiver. The call system is designed for easy installation. It is of the wired type and the Rad-O-Fone unit plugs into the back of the radio chassis. The receiver features automatic tuning,

## A Good Idea

Radio servicemen and experimenters can recall the numerous occasions when a friction tape binding had



## MAKING CATHODE-RAY TUBES FOR TELEVISION RECEIVERS

*When television comes, in America in a permanent commercial way, the demand for cathode-ray tubes here will be sensational. It will call for trained engineers and hundreds of specialized operators to make the delicate parts on them, to assemble them and to test the finished product. Scene shows workers assembling tubes for the Phillips factory in Holland.*

to be made, it would be necessary to split the standard 3/4 inch size tape in order to obtain a successful and neat wrapping. The Plymouth Rubber Company, realizing the need for a more convenient size tape, easier to handle and at the same time eliminating waste, recently introduced their new "Radio Friction Tape." As illustrated, the carton contains the regular 3/4 inch "Slipknot" tape cut into two 3/8 inch rolls. It is a practical size applicable to most radio and electrical work. The manufacturer



points out that with this new tape a binding can be made directly from the roll, further eliminating waste.

## Capacity Relay

The Luxtrol Company is the manufacturer of the capacity-operated relay illustrated below. It operates on either alternating or direct current, its output is designed to handle loads

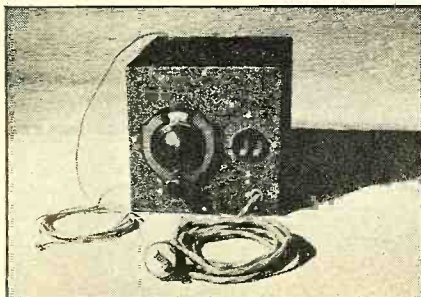

up to 800 watts. It is compact and is designed for easy installation and adjustment. This device offers a novel means for actuating advertising displays, protecting valuables, etc., and should prove an excellent side-line for servicemen.

## Equipped with Latest Advancements

The new model RFO-4 oscillograph, recently announced by the Hickok Electrical Instrument Company, especially features a self-contained demodulator which enables stage-by-stage trouble shooting. A built-in electronic frequency modulator, operating on 665 kc. simplifies connections and makes possible selectivity measurements. Other features include a return trace eliminator, high sensitivity, horizontal and vertical amplifiers, rotatable cathode-ray

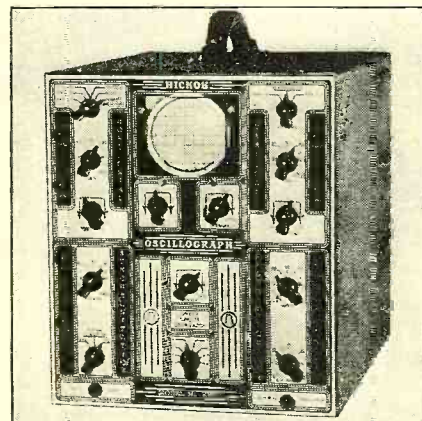

tube and simplicity of controls. The steel case measures 11 by 13 by 15 inches.

## Latest Tube Checker

The new model "U" tube checker  
(Turn to page 434)





# An Easy-To-Build 80-Watt C. W. RIG

(Utah Kit No. 1)

By Oliver Read, W9ETI

### YOU CAN DUPLICATE THIS

*Compact, yet not crowded, this kit applies commercial principles of design to the home-built "ham" rig with the net result that appearance and operating effectiveness are well above the average.*

IT has been and still is an almost universal practice among amateurs to build their own transmitter equipment. However, within the past year or two there has been a definite trend toward the use of kits, one of which is here illustrated and briefly described.

THIS kit, which has found a good deal of favor because it combines the features of low cost and high effectiveness, is the Utah Transmitter Kit No. 1. Starting with the No. 1 described here, other Utah kits can be added until a complete 500-watt phone and c.w. transmitter has been completed.

This kit No. 1 consists of a steel cabinet, two chassis and all parts as shown in the accompanying photographs except tubes, meters and crystal. The chassis are supplied with the sockets mounted in position and all holes drilled for mounting other parts. The construction job is, therefore, purely one of assembly and wiring, involving nothing more complicated than a soldering iron, a screw-

driver and a pair of pliers.

The circuit of this complete transmitter kit is shown in Figure 1.

The oscillator circuit is one of the regenerative, crystal control types which is highly stable and provides an abundance of harmonics. In spite of the use of regeneration, the crystal current is kept down to well within safe limits.

The r.f. amplifier employs two 6L6's, parallel connected, this type of circuit being favored as the one which provides a reasonably high output with minimum current consumption and with minimum excitation.

### Reserve Power

Although this r.f. unit could be pushed to 100 watts input, no attempt is made to do this but instead the overall input is held to an average of between 80 and 90 watts which provides 60 to 72 watts output. Jacks are provided for measuring the various grid and plate currents to provide a complete check on operation. Later, should a modulator be added, the modulator output is simply

plugged into the meter jack "J4" thus involving no changes in basic circuit of the r.f. kit. In such service, the r.f. plate current is measured by inserting the meter in the jack "J3". For c.w. operation, "J3" is the jack employed for keying.

Complete construction sheets are supplied to those purchasing the kit. In addition to other information, these sheets include complete winding data for all coils for the 20, 40, 80 and 160-meter bands. Operation on 10 meters is also possible, preferably using a 20-meter crystal.

### Costs Little

The two photographs and the circuit diagram tell the story of this professional appearing kit which is well within the ability of any amateur to construct and put on the air. Not the least of its advantages is the fact that this kit with the necessary tubes, meters and crystal costs considerably less than medium grade receivers of the type used in amateur communication work. The transmitter kit idea is definitely here to stay now that its economy and efficiency are becoming more evident.

(Readers who desire information on the values of resistors, condensers, etc., shown in the circuit diagram may address inquiries to the author, in care of RADIO NEWS.)

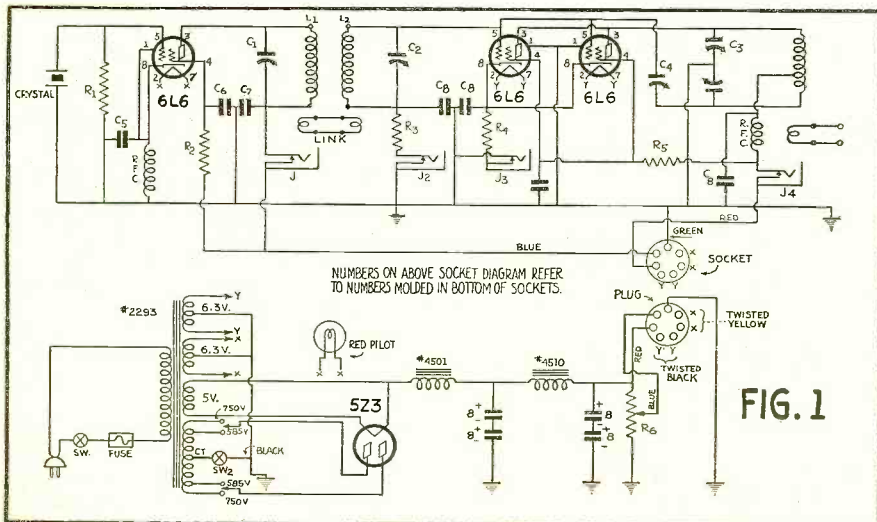

**NOTHING HAYWIRE HERE!**  
*As neat from behind as from the front—and easy to duplicate because chassis is furnished completely drilled and with small parts mounted.*

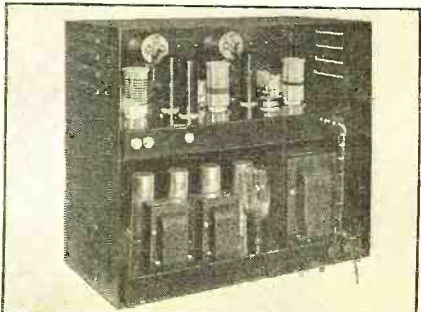



*The*  
**HAM**  
*This Month:*

**SHACK**

- Amateur Microphones
- Reproduction Quality
- Care and Handling
- Characteristic Tables
- The 833 Tube

*Conducted by*  
**E. M. Walker**  
Editor for Amateur Activities

## The Matter of "HAM" Microphones

"WHAT type microphone shall I use?" is a question frequently asked by the amateur contemplating phone for the first time. At the same time old-time phone men debate the merits of the many available types at great length. Each has his favorite, each has his prejudices. But when the question is reduced to its simplest form, it might be argued that regardless of how much is spent for a microphone it can be no better than the transmitter with which it is used.

ACTUALLY, as with everything else, there are good and bad microphones, but thanks to the progressiveness of manufacturers the bad ones are decidedly in the minority. Most of the microphones offered to the amateur today, ranging in price from more than \$5 upward, are satisfactory. It is important, however, to remember that a good microphone used with poor speech equipment can sometimes sound much worse on the air than a poor one used with good equipment. The point is:

BRUSH MODEL BR2S



if the speech equipment is constructed to match the microphone used, good results can be obtained.

The microphone used in the amateur transmitter does not necessarily have to have the characteristics of a "broadcast" type in order to "sound good" over the air. The requirements for the transmission of speech do not make it necessary to "pick up" the high over-tones of music and the bass notes of an orchestra. Rather, speech frequencies are limited to a somewhat narrow margin on the audio scale, and sometimes a microphone that will faithfully reproduce these frequencies will sound better on the



STROMBERG NO. 5-SB

air than one capable of covering the wide range of the musical scale and thus pick up unwanted noises and "lip" characteristics.

In buying a microphone it is nice to have one that is capable of reproducing a wide band of frequencies for the personal satisfaction derived from having good equipment. Actually, however, a microphone that will faithfully reproduce audio sounds between 100 and about 3,000 cycles will perform satisfactorily on the voice of the average person. As a matter of fact a large number of amateurs now are incorporating in

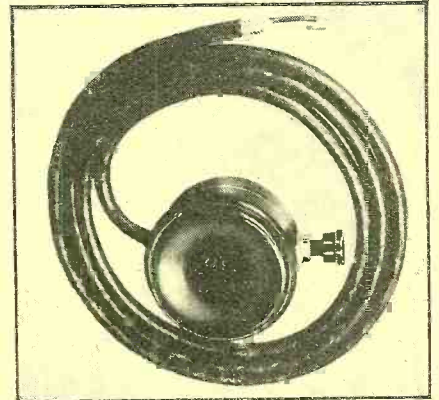

NEW UNIVERSAL MIKE

their speech equipment audio filters designed to cut out frequencies below 100 to 200 cycles and above 3,000 cycles so as to obtain a higher average modulation level and at the same time keep the transmitter's sidebands at a minimum, thus reducing interference on the amateur phone bands.

One of the most popular type of microphone in use today is the crystal type which makes use of two plates between which a Rochelle salt crystal is mounted. This type of microphone (which was invented in England almost ten years ago) has become popular only within the last two years. It has a number of attractive features, principally among which are low cost, dependability, good quality, low noise-level and simplicity in connecting in a transmitter. Such microphones have output levels ranging from about minus 45 db to minus 100 db. With the variety of high voltage-gain tubes available today this comparatively low output level is not a disadvantage. They require an audio amplifier with an audio gain from 80 db to 120 db. With an amplifier capable of this amount of gain, driver and modulator tubes may be driven to full output.

Carbon microphones of both single and double-button types are still used by a large number of amateurs. The double-button types deliver far better



**Q** A Department for the amateur operator to help him keep up-to-date



SHURE "TRIPOLAR" CRYSTAL

quality than the single-button types, although they are not quite as sensitive as the single-button units. However, the output level from a double button microphone is considerably higher than that from crystal microphones. The chief disadvantage of a carbon button is that it has an inherent noise due to the necessity of passing a low current through the carbon buttons in order to make it function. A double button microphone may be purchased from \$5 to \$50.

Next in popularity are the ribbon, condenser and sound cell (crystal) microphones. Most of these are more expensive than the types just mentioned, but are exceptionally good from a fidelity standpoint. The dynamic microphone operates on the same principle as the dynamic loudspeaker, only in reverse. The condenser microphone uses a tightly stretched sheet of metal spaced close to a solid plate, and converts sound

BRUNO "VELOTRON"



# The New 833 Tube

By Robert Ames

**N**EW tubes designed with the view of improving the efficiency of transmitting equipment are constantly making their debut on the market. With the tube equipment available today, the amateur has a choice that meets almost any requirement. Most recent among the new tubes is the 833 introduced last month by RCA. This tube is a high-output triode, designed for both medium and ultra-high-frequency operation. It may be used as an oscillator, radio-frequency amplifier or Class B modulator.

The tube is in the 1 kilowatt class. Its most unusual feature is its shape. It is a compact tube having grid and plate leads at one end and filament terminals at the other. Its design makes possible both short leads (within the envelop) and to the terminals of the tube in the circuit in which it may be used. The tube is round and about 8½ inches in length overall.

into an audio component by the variations in capacity resulting from the audio impressed on the thin plate. The ribbon microphone, as its name implies, uses a ribbon suspended between two magnets which is caused to vibrate when an audio sound is impressed upon it, thus inducing variations in the electro magnetic circuit. These three types of microphones range in price from about \$15 upward with the top limit of types available to the amateur about \$50. They are used by amateurs who have the best of equipment and glory in being classified as stations with "broadcast quality."

Microphones are perhaps the most delicate instruments used in a phone transmitter. Because they are constantly being handled, they are subjected to damage more than any other piece of equipment. Further, any slight damage due to a knock or fall may impair the quality of the unit, or put it out of commission completely. Good care is essential! When not in use, it should be protected with some sort of covering to keep dust and moisture out. It should not be exposed to places where

The tube has a plate dissipation of 300 watts and will take a maximum of 1,250 watts input, making it ideal for use in a single-tube, one-kilowatt amplifier stage. It is designed for operation at normal input, at frequencies up to 30 megacycles and will operate at 100 megacycles with slightly reduced input. Its ratings are:

- Grid to plate capacity.....6.3 mmfd.
- Grid to filament capacity.....12.3 mmfd.
- Plate to filament capacity.....8.5 mmfd.
- Filament voltage.....10 volts
- Filament current.....10 amperes
- Maximum plate voltage.....3,000 volts
- Maximum plate current...500 milliamperes
- Maximum grid current...75 milliamperes

The tube is a high-mu type, having

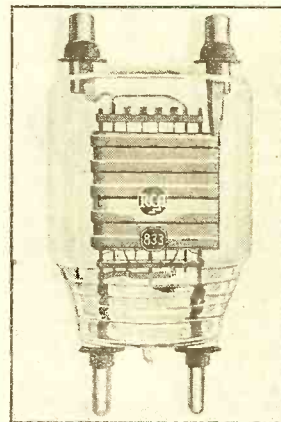

an amplification factor of 35. Its manufacturers claim in properly designed circuits plate efficiencies of 80-percent are possible. Also that it has a low driving-power requirement, 25 watts being sufficient to drive the tube at one kilowatt input.

extremes of temperature are to be encountered; it should never be exposed to high humidity or dampness unless it is especially designed for use under these conditions.

As much care electrically as mechanically should be given a good microphone. Carbon microphones particularly should not be given an overload of current. Excessive currents will freeze the carbon granules

(Turn to page 436)

ASTATIC MODEL D-104





## The Radio News

# "PROGRESSIVE" Transmitter

**T**HIS modulator is designed around the versatile characteristics of the 6L6 beam tube. Under the Class AB2 mode of operation, a theoretical output of 55 to 60 watts is obtainable from a pair of these tubes under ideal operating conditions. This class of operation, however, is not recommended. In addition to requiring appreciable grid driving power there is also the necessity for a fixed bias voltage and tube life is shortened considerably.

For actual output powers in the vicinity of 60 watts a preferable arrangement is to operate four 6L6's in push-pull-parallel under class AB1 conditions. The advantages of self-bias operation and lack of necessity for grid driving power are retained while the output is higher, with less distortion than a single pair of 6L6's being pushed hard in class AB2 operation. The plate and screen voltages remain the same for both AB1 and AB2 operation while the current requirements are very nearly the same.

### Simple Circuit Used

The use of four 6L6's in class AB1 lends itself nicely to our requirement for a modulator that will both economically and efficiently modulate the 807, and later the pair of T20's. For modulation of the 807 only two

### 60-WATT MODULATOR

*This is the finished modulator. Temporarily two of the 6L6's are omitted as the other two provide more than ample power to modulate the low-power r.f.*

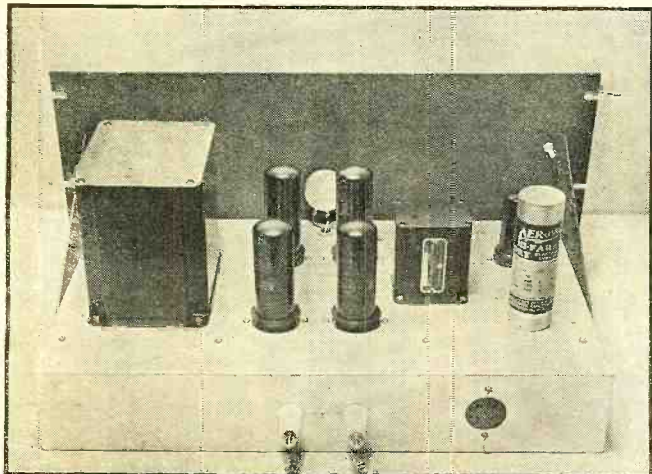

**T**HIS is the second of a series of four articles describing a high-grade transmitter, the construction of which can be spread over as long a period of time as desired but which can go on the air with the completion of the 2-tube, 25-watt exciter and its power supply, both of which were described last month. This month a modulator is described, the addition of which converts this exciter into a 25-watt phone rig. The third and fourth articles will describe the additional units necessary to wind the job up as a modern 110-watt phone transmitter for use on all bands from 10 to 80 meters, and even on 160 meters.

### By Chester Watzel and Willard Bohlen

#### (Part Two—The Modulator)

of the 6L6's are used. As the current required is not much over a hundred ma. the 400-volt supply for the low-power r. f. unit can supply both this unit and the modulator. This saves an extra supply for low-power phone operation. For full audio output for later requirements, of course, all four 6L6's are used. A separate 400-volt power supply, to be described in the final article, is then used for the modulator alone.

There is, actually, very little to the modulator outside of the push-pull-parallel power stage. As the grids of the 6L6's require only voltage drive the voltage amplifier section of the modulator is quite simple. A single 6N7 is all that is necessary to do the job. This tube is the metal tube version of the more familiar 53 or 6A6.

For the sake of clarity the 6N7 is shown in the modulator diagram as two separate tubes.

The two sections of the 6N7 are used as two separate resistance-coupled stages. The overall gain of these two stages is sufficiently high to swing the grids of the 6L6's from a standard type of crystal microphone, or from a Velotron which has even higher output than the crystal microphone.

As the two sections of the 6N7 are resistance coupled, audio transformers are required only in the modulator stage. By avoiding the use of transformers in the early stages we economize and at the same time eliminate a prolific source of hum, instability and feed-back.

Several other circuit features are worthy of note. An r. f. choke is used between the microphone jack, J, and the grid of the first section of the 6N7. This removes any r. f. that may be picked up by either the microphone or its connection cord. A shielded plug should be used to eliminate any possible r. f. pickup at this point.

### Thorough Filtering

R3 and C2 form a decoupling filter for the 6N7 first section. Additional filtering is provided by R7 and C3. R7 also reduces the voltage for the

### UNDER VIEW OF MODULATOR

*A neat job and a well balanced layout. The two adjustable resistors permit alteration of screen and grid-bias voltages for two or four 6L6's.*

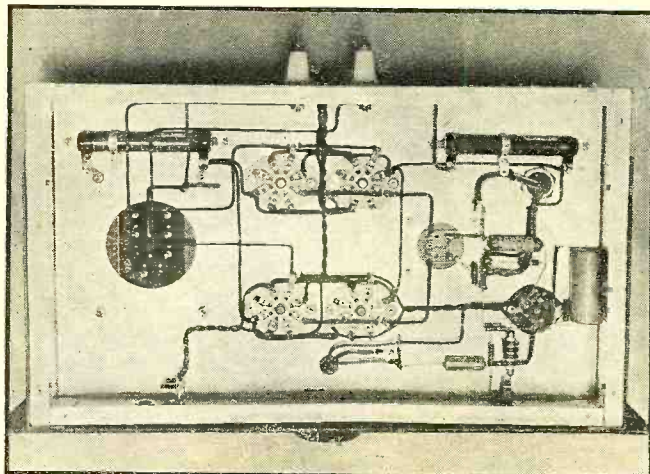



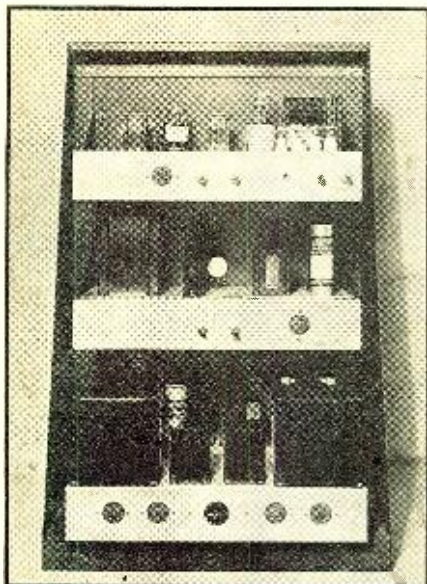

**UNITS INTERCHANGEABLE**

Here, from top to bottom, are the r.f., modulator and power units of the low-power rig. Later the high-power final will be included in this rack and the modulator moved to a second rack.

plates of the 6N7 and screens of the 6L6's to approximately 300 volts. Although R7 has a slider, the full resistance value is employed when the modulator is run with two 6L6's. The same applies to the cathode resistor R6. These are both capable of handling the full current of four tubes.

**Modulating Transformer**

The Ken-O-Tap modulation transformer, T1, will handle up to 75 watts and will match any combination of modulator tubes to any r. f. load or low-impedance line. The plate impedance of a pair of 6L6 tubes in class AB1 is 6600 ohms, while the plate impedance of four tubes is 3800 ohms. As it happens, the primary taps stay the same for either combination of tubes; the plates to 1 and 6, B-plus to 2 and 5 which are joined together. One secondary connection may be permanently made to tap A. For use with two 6L6's modulating the 807 the other secondary connection should be made to tap C. Later, when all four tubes are used the only change in connections to this output transformer is to change from tap C to tap D.

**Testing Modulation**

For preliminary test of the modulator for a lamp bulb may be used to check the approximate output. A thirty-watt bulb (ordinary electric light type) is connected from tap A to tap B on the output transformer. This will give an approximate match from the modulator to the bulb. It should be possible to light the bulb to full brilliancy when whistling several inches from the microphone. Any

standard type of high output (around minus 56 db.) crystal microphone has sufficient output to produce the full 30 watts of audio power from the modulator.

**Rack and Panel**

The photographs show the transmitter mounted in one rack for low-power phone operation. The rear view photo shows the 750-volt power supply built into place on the lower chassis, along with the 400-volt supply. This 750-volt supply is not, of course, necessary for low-power phone, but had been built into the model in order to permit tests to be completed before writing the next installment of this series.

For low-power c. w. operation the "modulator" terminals are shorted. For phone operation the jumper wire is taken off and the two terminals connected to the corresponding terminals immediately below on the modulator chassis.

The full available output from the modulator with only two 6L6's in place is enough to cause severe overmodulation of the 807 carrier. This makes it important to check the modulation percentage and keep the gain turned well down to be sure that an overmodulation condition does not exist.

**Keying Precautions**

It might be advisable to mount a small knife switch across the modulator terminals so that they may be shorted when keying the transmitter for c. w. Keying thru an unshorted modulation transformer causes peak voltages to build up which are liable to cause bad key clicks and may damage the transformer.

For c. w. operation alone either the old or new types of 807 may be employed. For phone work, however, it is advisable to use one of the newer types which have a rating approximately 50 percent higher than the old. The old type is rated for only 325 volts on the plate for phone operation. For c. w. operation its rating is 400 volts.

Next month's article, the third in this series, will describe the 750-volt

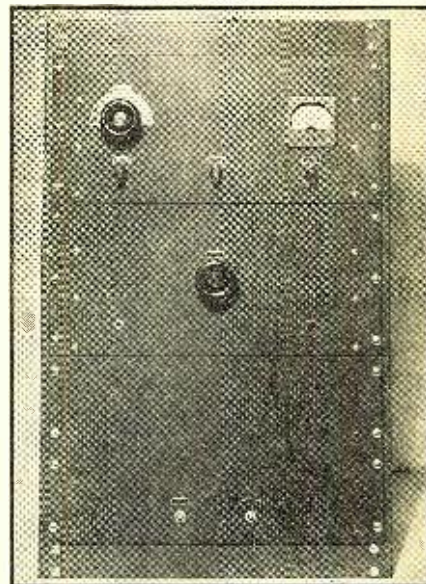

**THE 25-WATT PHONE**

The units described in this and the preceding article, mounted on a single rack as shown here, can be put in service pending completion of the high-power r.f. final and its power supply.

power supply and also the push-pull T20 r. f. stage. With this latter T20 stage mounted in place of the modulator unit, a complete 110-watt c. w. transmitter will be contained in the one single rack.

**Parts List**

- C Aerovox electrolytic, 25 mfd., 50 v.
- C1 Aerovox tubular, .01 mfd., 400 v.
- C2, C3 Aerovox dual filter, 8-8 mfd., 450 v.
- C4 Aerovox tubular, .01 mfd., 400 v.
- C5 Aerovox filter, 8 mfd., 450 v.
- J Yaxley type A-1 jack
- R IRC 5 megohms, 1/2 watt
- R1 IRC 2,000 ohms, 1/2 watt
- R2 IRC 250,000 ohms, 1/2 watt
- R3 IRC 50,000 ohms, 1/2 watt
- R4 Yaxley type M 250,000 potentiometer
- R5 IRC 250,000 ohms, 1/2 watt
- R6 Ohmite type 0567 wirewound with slider, 200 ohms, 50 watts
- R7 Ohmite type 0583 wirewound with slider, 15,000 ohms, 50 watts
- RFC Hammarlund type CH-X r.f. choke
- T Kenyon type T52 single plate to pushpull grids interstage transformer
- T1 Kenyon type T494 Ken-O-Tap output transformer, 75 watts
- 2 Birnbach feedthrough insulators
- 4 Hammarlund type S-8 octal Isolantite sockets
- 1 Parmetal type 3604 panel, 8 3/4 by 19
- 1 Parmetal type TR-3220 table type relay rack

(Turn to page 431)

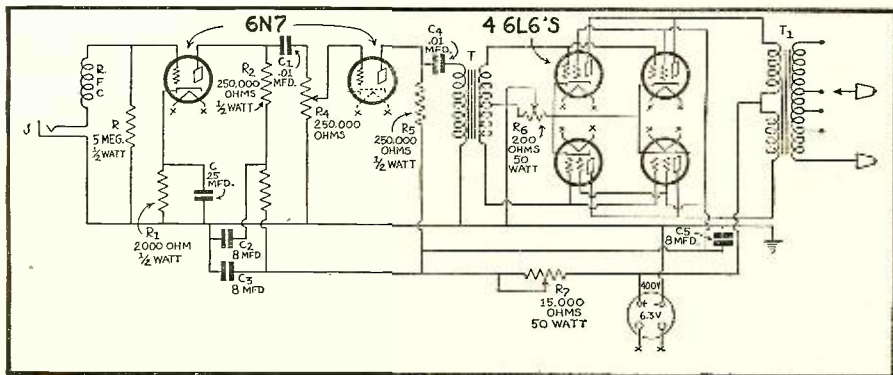



# EUROPEAN STATION LIST

(For Medium and Long Waves)

Conducted by John M. Borst

ALBANIA			
Call	Location	kc.	kw.
....	Tirana (under construction)	1384	.....

AUSTRIA			
Call	Location	kc.	kw.
....	Innsbrueck	519	1.0
....	Vienna	592	100.0
....	Graz	886	15.0
....	Linz	886	15.0
....	Klagenfurt	1294	5.0
....	Vorarlberg	1294	5.0
....	Salzburg	1348	2.0

BELGIUM			
Call	Location	kc.	kw.
....	Brussels I	620	15.0
....	Brussels II	932	15.0
....	Brussels	1122	0.1
....	Schaerbeek	1122	0.1
....	Libramont	1122	0.1
....	Antwerp	1465	0.1
....	Ghent	1464 & 1482	0.1
....	Loxbergen	1122 & 1482	0.1
....	Binche	1491	0.2
....	Chateleineau	1491	0.2
....	Courtrai	1491	0.1
....	Andrimont	1500	0.1
....	Liege	1500	0.1
....	Liege	1500	0.1
....	Liege	1500	0.1
....	Seraing	1500	0.1
....	Vellereille-le-Brayeau	1500	0.1
....	Verviers	1500	0.1

BULGARIA			
Call	Location	kc.	kw.
....	Sofia	850	1.0
....	Varna	1267	2.0
....	Stara Zagora	1402	2.0

CZECHOSLOVAKIA			
Call	Location	kc.	kw.
....	Banska Bystrica	392	30.0
....	Prague (Libice)	638	120.0
....	Brno	922	32.0
....	Bratislava	1004	13.5
....	Moravska Ostrava	1113	11.2
....	Kosice	1158	2.6
....	Prague (Strasnice)	1204	5.0

DANZIG			
Call	Location	kc.	kw.
....	Danzig	1303	0.5

DENMARK			
Call	Location	kc.	kw.
OXP	Kalundborg	240	60.0
OXQ	Copenhagen	1176	10.0

ESTONIA			
Call	Location	kc.	kw.
....	Tartu	517.2	0.5
....	Tallinn (Reval)	731	15.0

FINLAND			
Call	Location	kc.	kw.
....	Lahti	166	220.0
....	Oulu	431	10.0
....	Viipuri (Viborg)	527	10.0
....	Pori (Bjorneborg)	749	1.0
....	Sortavala	776	0.25
....	Helsinki (Helsingfors)	895	10.0
....	Tampere (Tammerfors)	1348	0.7
....	Vaasa (Vasa)	1420	0.5
....	Turku (Abo)	1429	0.5
....	Pietarsaari (Jakobstad)	1500	0.25

FRANCE			
Call	Location	kc.	kw.
Radio Paris	Paris (to be increased to 200 kw.)	182	80.0
Alpes-Grenoble	Grenoble	583	15.0
Lyon PTT	Lyons	648	90.0
Paris PTT	Paris	695	120.0
Marseille PTT	Marseilles	749	100.0
Toulouse PTT	Toulouse	776	120.0
Radio Agen	Agen	832	0.5
Radio Strasbourg	Strasbourg	859	100.0
Limoges PTT	Limoges (to be increased to 100 kw.)	895	1.5
Radio Toulouse	Toulouse	913	8.0
Poste Parisien	Paris	959	60.0
Radio Sud-Ouest	Bordeaux	968	2.5
Rennes-Bretagne	Rennes	1040	120.0
Bordeaux-Lafayette	Bordeaux (to be increased to 100 kw.)	1077	25.0
Radio Normandie	Fecamp	1113	0.7
Nice-Cote d'Azur	Nice	1185	60.0

Call	Location	kc.	kw.
Radio-PTT-Nord	Lille	1213	60.0
Radio-Mediterranee	Antibes	1276	0.5
Radio-Cite	Paris	1348	2.0
Montpellier-Languedoc	Montpellier	1352	1.2
L'ile de France	Paris	1366	0.7
Radio Lyon	Lyons	1393	25.0
Rueil-Malmaison	Paris	1429	2.0
Tour Eiffel	Paris	1456	5.0
Radio Nimes	Nimes	1492	0.7

GERMANY			
Call	Location	kc.	kw.
....	Koenigswusterhausen	191	60.0
....	Muchlacker	574	100.0
....	Langenberg	658	100.0
....	Munich	740	100.0
....	Leipzig	785	120.0
....	Berlin-Tegel	841	100.0
....	Hamburg	904	100.0
....	Breslau	950	100.0
....	Koenigsberg	1031	100.0
....	Frankfurt on Main	1195	25.0
....	Freiburg	1195	5.0
....	Kassel	1195	0.5
....	Koblenz	1195	2.0
....	Trier	1195	2.0
....	Gleitwitz	1231	5.0
....	Goerlitz	1231	5.0
....	Saarbruecken	1249	17.0
....	Nurnberg	1267	2.0
....	Dresden	1285	0.25
....	Bremen	1330	2.0
....	Flensburg	1330	2.0
....	Hannover	1330	2.0
....	Magdenburg	1330	0.5
....	Stettin	1330	2.0
....	Stoip (under construction)	1330	.....
....	Koenigsberg II	1348	2.0
....	Kaiserslautern	1429	0.5
....	Dresden (under construction)	1465	5.0

GREECE			
Call	Location	kc.	kw.
....	Athens (under construction)	601	100.0

HUNGARY			
Call	Location	kc.	kw.
HAL2	Budapest II	360	18.0
HAL	Budapest I	546	120.0
HAE	Nyiregyhaza	1122	6.25
HAE2	Magyarovar	1321	1.25
HAE3	Miskloc	1438	1.25
HAE4	Pecs	1465	1.25

ICELAND			
Call	Location	kc.	kw.
TFU	Reykjavik	208	16.0

IRISH FREE STATE			
Call	Location	kc.	kw.
....	Athlone	565	100.0
6CK	Cork	1240	1.0
2RN	Dublin	1348	0.5

ITALY			
Call	Location	kc.	kw.
I1BZ	Bolzano	536	10.0
I1PA	Palermo	565	3.0
I1FI	Florence	610	20.0
I1RO	Rome I	713	120.0
I1MI	Milan I	814	50.0
I1GE	Genoa	986	10.0
I1BA	Bari I	1059	20.0
I1NA	Naples	1104	10.0
I1TS	Trieste	1140	10.0
I1TO	Turin I	1140	7.0
I1BO	Bologna	1222	50.0
I1RO3	Rome III	1258	1.0
I1BA2	Bari II	1357	1.0
I1MI2	Milan II	1357	4.0
I1TO2	Turin II	1357	0.2

LATVIA			
Call	Location	kc.	kw.
YLZ	Riga	583	15.0
....	Madona	1104	50.0
....	Kuldiga	1258	10.0
....	Liepaja	1734	0.1

LITHUANIA			
Call	Location	kc.	kw.
LYX	Kaunas	155	7.0
LYY	Klaipeda	565	10.0

LUXEMBURG			
Call	Location	kc.	kw.
....	Luxemburg	232	200.0

NETHERLANDS			
Call	Location	kc.	kw.
....	Kootwijk	160	10.0
PX-I	Hilversum	995	15.0
....	....	....	60.0

NORWAY			
Call	Location	kc.	kw.
LKA	Vigra	253	10.0
LKO	Oslo	260	60.0
LKM	Tromso	282	10.0
LKI	Finnmark	347	10.0
LKH	Hamar	519	0.7
LKT	Trondelag	629	20.0
LKK	Kristiansand	629	20.0
LKF	Frederikstad	722	1.0
LKB	Bergen	722	1.0
LKD	Bodo	850	10.0
LKP	Porsgrunn	850	1.0
LKS	Stavanger	850	10.0
LKG	Narvik	1222	0.3
LKR	Rjukan	1348	0.15
LKN	Notodden	1357	0.25

POLAND			
Call	Location	kc.	kw.
....	Warsaw I, (Raszyn)	224	120.0
....	Wilno	536	50.0
....	Katowice	758	12.0
....	Lwow	795	50.0
....	Poznan	868	16.0
....	Torun	986	24.0
....	Krakow	1022	1.8
....	Lodz	1339	2.0
....	Warsaw II, Mokotow	1384	7.0

PORTUGAL			
Call	Location	kc.	kw.
....	Lisbon	629	20.0
CTIGL	Parede	1031	5.0
CTIBO	Lisbon	1348	0.05
CTIAN	Lisbon	1411	0.04
CTIDH	Lisbon	1411	0.05
CTIDR	Lisbon	1411	0.04
CTIEB	Lisbon	1411	0.04
CTIIV	Lisbon	1411	0.04
CTIMO	Lisbon	1411	0.04
CSISR	Oporto	1411	0.03
CTIKM	Lisbon	1412	0.04
CS1IR	Oporto	1429	0.25
CS1BI	Oporto	1429	0.05
....	Oporto	1429	0.03
CS1RP	Oporto	1429	0.01
CS1RG	Oporto	1429	0.05
....	Oporto	1429	0.03
....	Oporto	1429	0.03
CS1AA	Lisbon	1492	0.04
CS1CF	Oporto	1492	0.03

RUMANIA			
Call	Location	kc.	kw.
....	Bod (near Brasov)	160	150.0
....	Bucarest	823	12.0

SPAIN			
Call	Location	kc.	kw.
It was found impossible to obtain complete authoritative data. The following list was compiled from several sources; changes may be expected at any moment.			
....	Madrid	183	1.0
EAJ2	Madrid	731	3.0
EAJ5	Seville	731	3.0
EAJ1	Barcelona	795	7.5
EAJ3	Valencia	850	1.5
EAJ15	Barcelona	1022	1.0
EAJ19	Oviedo	1022	1.0
EAJ7	Madrid	1095	12.0
EAJ56	Salamanca	1095	.....
EAJ8	San Sebastian	1258	3.0
EAJ28	Bilbao	1258	0.6
EAJ62	Vitoria	1420	0.2
EAJ4	Santiago de Compostela	1492	0.2
EAJ6	Pamplona	1492	0.2
EAJ9	Malaga	1492	0.2
EAJ10	Zaragoza	1492	0.2
EAJ12	Alcoy	1492	0.1
EAJ13	Palma de Mallorca	1492	0.1
EAJ16	Granada	1492	0.2
EAJ17	Murcia	1492	0.2
EAJ20	Sabadell	1492	0.2
EAJ21	Melilla j	1492	0.2
EAJ23	Gandia	1492	0.2
EAJ24	Cordoba	1492	0.1
EAJ27	Burgos	1492	0.2
EAJ31	Alicante	1492	0.2
EAJ33	Tarragona	1492	0.2
EAJ34	Gijon	1492	0.2
EAJ39	Badalona	1492	0.2
EAJ41	La Coruna	1492	0.2
EAJ42	Larida	1492	0.2



Call	Location	kc.	kw.
EAJ43	S. C. Tenerife	1492	0.2
EAJ44	Albaceta	1492	0.2
EAJ46	Ceuta	1492	0.2
EAJ47	Valladolid	1492	0.2
EAJ48	Vigo	1492	0.2
EAJ51	Manresa	1492	0.2
EAJ52	Badajoz	1492	0.2
EAJ54	Alcira	1492	0.11
EAJ57	Orense	1492	0.2
EAJ58	Jerez Fra (Cadiz)	1492	0.2
EAJ60	Almeria	1492	0.2
EAJ61	Jaen	1492	0.2
EAJ65	Ciudad Real	1492	0.2
EAJ11	Reus	1500	0.2
EAJ14	Castellon	1500	0.2
EAJ18	Logron	1500	0.2
EAJ22	Huesca	1500	0.2
EAJ25	Tarassa	1500	0.1
EAJ26	Antequera	1500	0.2
EAJ29	Alcala de Henares (Madrid)	1500	0.2
EAJ30	Onteniente (Valencia)	1500	0.1
EAJ32	Santander	1500	0.2
EAJ35	Villanueva Geltru (Barcelona)	1500	0.2
EAJ36	Jativa	1500	0.2
EAJ37	Linares	1500	0.2
EAJ38	Gerona	1500	0.2
EAJ40	Pontevedra	1500	0.2
EAJ45	Denia	1500	0.04
EAJ49	Toledo	1500	0.2
EAJ50	Las Palmas	1500	0.2
EAJ52	Elche	1500	0.2
EAJ55	Algeciras	1500	0.2
EAJ63	Leon	1500	0.2
EAJ64	Segovia	1500	0.2
EAJ68	Lugo	1500	0.2

**SWEDEN**

SBG	Motala	216	150.0
SBE	Boden	392	0.6
SBF	Ostersund	413.5	0.6
SRD	Sundsvall	601	10.0
SBA	Stockholm	704	55.0
SCN	Malmberget	704	0.2
SBG	Goteborg	941	10.0
SCC	Falun	1086	2.0
SBH	Horby	1131	10.0
SCB	Eskilstuna	1240	0.2
SCP	Safle	1240	0.4
SCU	Varberg	1240	0.2
SCV	Orebro	1240	0.2
SCL	Kiruna	1258	0.2
SBC	Malmo	1312	2.5

Call	Location	kc.	kw.
SCK	Karlstad	1312	0.25
SCO	Norrkoping	1312	0.25
SCQ	Trollhattan	1312	0.25
SCG	Halsingborg	1384	0.2
SCF	Hudiksvall	1402	1.0
SCS	Umea	1402	1.0
SCW	Ornskoldsvik	1402	0.5
SCE	Halmstad	1411	0.2
SCR	Uddevalla	1411	0.05
SCA	Boras	1447	0.2
SCI	Kalmar	1447	0.2
SCD	Gavle	1482	0.2
SCT	Uppsala	1492	0.2
SCM	Kristinehamn	1500	0.2
SCH	Jonkoping	1515	0.2
SCJ	Karlskrona	1530	0.2

**SWITZERLAND**

....	Geneva	401	1.3
....	Beromunster	556	100.0
....	Sottens	677	100.0
....	Monte Ceneri	1167	15.0
....	Basel	1375	0.5
....	Bern	1375	0.5

**TURKEY**

TAJ	Istanbul	186	3.0
-----	----------	-----	-----

**UNITED KINGDOM**

Droitwich National	Droitwich	200	150.0
North Regional	Moorside		
	Edge	668	70.0
Scottish Regional	Westerglen	767	50.0
....	Burghead	767	60.0
....	Pennion	804	5.0
West Regional	Washford	804	70.0
London Regional	Brookmans Park	877	50.0
Northern Ireland Regional	Lisburn	977	100.0
Midland Regional	Droitwich	1013	70.0
Scottish National	Westerglen	1050	50.0
Newcastle	Newcastle	1122	1.0
London National	Brookmans Park	1149	20.0
North National	Moorside		
	Edge	1149	20.0
West National	Washford	1149	20.0
Aberdeen	Aberdeen	1285	1.0
Bournemouth	Bournemouth	1474	1.0
Plymouth	Plymouth	1474	0.3

Call	Location	kc.	kw.
<b>U. S. S. R.</b>			
RV1	Moscow	172	500.0
RV10	Minsk-Kolodishchi	208	35.0
RV4	Kharkov	232	10.0
RV8	Baku	238	10.0
RV43	Moscow	271	100.0
RV7	Tiflis	283	35.0
RV3	Saratov	340	20.0
RV12	Rostov-on-Don	355	20.0
RV24	Smolensk	364	10.0
RV5	Sverdlovsk	375	40.0
RV21	Erivan	380	10.0
RV27	Makhach-Kala	390	4.0
RV49	Moscow	401	100.0
RV25	Voronezh	413.5	10.0
RV37	Ufa	436	10.0
RV45	Orenburg	461.5	1.0
RV41	Syktvykar	472	1.0
RV34	Stalingrad	522	10.0
RV42	Gorki	565	10.0
RV36	Arkhangelsk	586	10.0
RV35	Astrakhan	598	10.0
RV31	Ivanovo	625	10.0
RV29	Petrozavodsk	648	10.0
RV23	Grozny	676	1.0
RV17	Kazan	686	10.0
RV48	Elista	704	2.5
RV16	Kuibishev	713	10.0
RV9	Kiev	722	35.0
RV65	Saransk	734	1.0
RV74	Cheboksary	740	5.0
RV64	Ordzhonikidze	749	10.0
RV78	Izhevsk	767	4.0
RV26	Stalino	776	10.0
RV51	Naichik	794	1.0
RV39	Moscow	832	100.0
RV73	Simferopol	859	10.0
RV61	Ioshkar-Ola	888	1.0
RV30	Dnepropetrovsk	913	10.0
RV55	Engelsk	937	1.0
RV13	Odessa	968	10.0
RV67	Ukhta	968	2.0
RV86	Chernigov	1013	5.0
RV70	Leningrad	1040	40.0
RV33	Krasnodar	1050	1.0
RV57	Tiraspol	1063	4.0
RV75	Vinnitsa	1095	10.0
RV20	Kharkov	1185	20.0

**YUGOSLAVIA**

....	Ljubliana	527	5.0
....	Belgrade	686	2.5
....	Zagreb	1086	0.7

# New Unit for Testing Voices

By Samuel Kaufman

THE Columbia Broadcasting System has installed a radio device which permits actors to see their voices on an illuminated screen for the study of pitch, balance and other technical phases of their speech. The unit, known as the "Resonoscope," is a product of the Dumont Laboratories, and utilizes some television principles in operating technique.

Vibrations of the actor's voice or a series of tuning forks are fed into a cathode-ray tube through a crystal microphone used with a high-gain amplification unit. The wave-form seems to stand still when the horizontal sweep of electrons on the tube is the same as the vertical—or any multiple thereof. This occurs only when the frequency fed to the cathode valve is that of a given note.

A dial can be turned to one of twelve marks representing twelve



notes in one scale octave. With the dial on one marking, a stationary light pattern is shown on the screen and, simultaneously, the indicated note is hummed mechanically. A control then erases the pattern and to bring back the required design the actor must hum the designated note into a mike. If the note is given too sharp or too flat, the pattern, although reappearing, will move to the right or left. With the designated pitch and tone, however, the design remains stationary. The first application of the device was made on the Columbia Workshop series with Irving Reis using the Resonoscope for casting purposes.

**Super-Audible Sounds**

Boston, Mass.—An opportunity to explore a world of sound completely unknown to the average person will

be given by Professor George W. Pierce in the new Harvard University series of programs to be transmitted over W1XAL, Boston, Mass., 6.04 mc., Tuesday evenings, beginning November 2nd from 8 to 8:30 p. m.

**Changes in Division Personnel**

Washington, D. C.—Chairman Frank R. McNinch, of the Federal Communications Commission, recently announced that Commissioner George Henry Payne was elected Chairman of the Telegraph Division, and that he had designated Commissioner T. A. M. Craven as a temporary member of this same division.

**New Photo Tubes**

New York, N. Y.—Three new phototubes have been made available by RCA. These are types 921, 922, and 923. Types 921 and 923 are of a new construction; they are smaller and double-ended which eliminates the base and provides a long insulating path between anode and cathode. The terminals at either end are so designed as to permit inserting each tube easily and positively in a clip mounting. Type 921 is a gas-filled tube designed for a maximum anode supply of 90 volts; the maximum anode current 20 ma. The sensitivity is 100 micro-amps per lumen at zero frequency, 97 micro-amps per lumen at 5000 cycles and 90 micro-amps per lumen at 10,000 cycles. Type 922 is a vacuum tube, designed for a 250 volt anode supply; its sensitivity is 20 micro-amps per lumen. Type 923 is similar in characteristics and construction to type 918 except for a shorter overall length. It is a gaseous tube with a sensitivity of 100 micro-amps per lumen with a 90 volt anode supply.



THE BRITISH GUIANA BROADCASTING COMPANY.

Georgetown,



British Guiana.

V.P.3M.R.

"THE VOICE OF GUIANA"

6,010 SOUTH AMERICA.

7,000 Kcs. 150 Watts.

We have great pleasure in verifying your report of

reception of our programme on July 5th, 1936

Our present Schedule is—

Sundays 9 a.m.—11.30 a.m. 12.45 p.m.—3.15 p.m.

Week days 6 p.m.—10.00 p.m. 9.45 p.m.—1.45 a.m.

LOCAL TIME

GMT

## VERIFICATION CARD OF VP3MR

Our observer, Juan M. Salazar, of Cuba, sends us this unique verification card from the well known station at Georgetown, British Guiana.

THE Fifty-eighth installment of the DX Corner for Short-Wave contains the World Short-Wave Time-Table for 24-hour use all over the world and Official Observers' reports of stations heard this month. Consult these two items regularly and make your all-wave set pay big dividends!

## Credit Where It Is Due

The "star" list of short-wave Listening Post Observers this month includes: Welper, Alfred, Fleming, G. C. Gallagher, L. F. Gallagher, Myers, Diez, Dressler, Shamleffer. Our congratulations to these Members for their fine attention to detail, their persistently good catches and well-prepared reports.

## Reports of Listening Post Observers and Other Short-Wave Readers of the DX Corner

LISTED in the following columns is this month's consolidated reports of short-wave stations heard by our wide-world listening posts. Each item is credited with the Observer's surname. This allows our readers to note who obtained the information. If any of our readers can supply Actual Time Schedules, Correct Wavelengths, Correct Frequencies and any other Important Information (in paragraphs as recommended), the DX Editor, as well as our readers, will be grateful for the information. On the other hand, readers seeing these reports can try their skill in pulling in the stations logged and in trying to get complete information on these transmissions. The report for this month, containing the best information available to date, follows:

## Europe

"Radio Norte," Spain, 7050 kc., 5 p.m. (Betances).

"Radio Requete," Madrid, Spain, 7100 kc., news at 4:30 p.m. (Betances).

"Radio Espana," San Sebastian, Spain, 7250 kc., daily from 4 p.m. (Betances); 10,250 kc., irregularly 6-9 p.m. (Fleming).

"Radio Journal," San Sebastian, Spain, 41.65 meters, daily 12:30 p.m. (Westman).

EAQ, Madrid, Spain, 9860 kc., Sundays 4 p.m. on, daily 7 p.m. (Fleming, Shamleffer).

EAR, Madrid, Spain, 9478 kc., irregular 7:30-9:30 p.m. (Alfred); daily 6:30-8:30 p.m. and 10-11 p.m. (Markuson, Myers, Shamleffer, Diez); 10,400 kc. (Dressler), Slogan: "The Voice of Spain." Address: P. O. Box 951.

"Radio Bilbao," Spain, 7300 kc., daily from 4 p.m. (Betances).

"Radio National," Salamanca, Spain, 10,373 kc., daily 7:30-8:47 p.m., no call sign given but reports were requested (Alfred); 5-6:25 p.m. (Magnuson, Eder, Carroll, Nigh, Scala); 9-9:45 p.m.

## WELL KNOWN OBSERVER

Observer Luis Diez, of Retalhuleu, Guatemala, sends greetings to Radio News listeners. He had heard all continents on his Philco 116-B, shown below.

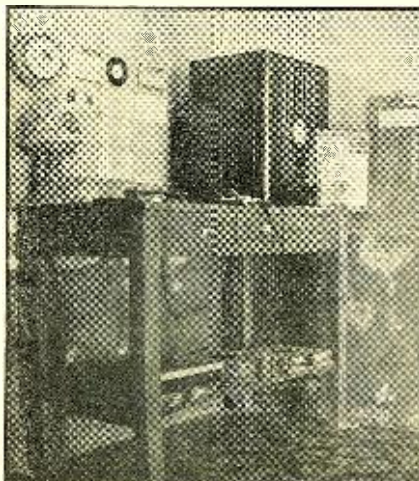

# The DX

for

# SHORT

Conducted by

(Sullivan, Dressler); 10,420 kc. (Gallagher, Kentzel, Poll, Markuson). Slogan: "Salute Franco; Arriba Espana."

"Radio Liberte," Paris, France, 9530 kc., announces in French and Italian. (Smith); signed 6:33 p.m. (Eder). Address: Radio Home, 10 Ave. de la Liberte, Becon Courbevoie.

TPA2, Pontoise, France, 15,243 kc., daily 6-11 a.m., chimes every quarter hour (Welper); 15,210 kc. (Diez).

TPA3, Pontoise, France, 11,885 kc., daily 12:15-5 p.m. (Welper, Fleming); 11 p.m. (Wollenschlager, Unger, Dressler).

TPA4, Pontoise, France, 11,720 kc., daily 6:15-8:15 p.m. and 10 p.m.-1 a.m. (Welper); 11,710 kc. (Pierce, Dressler); 11,630 kc. (Diez); daily 7-12 p.m. (Fleming, Black).

HBO, Geneva, Switzerland, 11,402 kc., Saturday 7-8:45 p.m. (Alfred); 2 p.m. (Westman); daily except Saturday 2-2:15 p.m. (Shamleffer, Fleming, Partner, Sargent).

HBJ, Geneva, Switzerland, 14,535 kc., Saturday 7-8:45 p.m. (Alfred); 1 p.m. (Westman, Shamleffer); daily at 11 a.m. (Westman).

HB9D, Zurich, Switzerland, 9535 kc., schedule: Sunday 9-11 a.m., Thursday 1-3 p.m. (N. C. Smith, Margie). Address: P. O. Box No. 2.

GSF, Daventry, England, 15,140 kc., daily 4-6 p.m. and 6:20-8:30 p.m. (Welper, Wollenschlager, Allison).

GSO, Daventry, England, 15,180 kc., daily 4-6 p.m. and 6:20-8:30 p.m. (Welper, Dressler).

GSH, Daventry, England, 21,470 kc., 8:45 a.m. on Sunday (Chadwick); daily 9:15-12 a.m. (Dressler).

GSP, Daventry, England, 15,310 kc. (Wollenschlager); daily 4-5:45 p.m. (Dressler, Diez);



# Corner

the

# WAVES

L. M. Cockaday



daily 6:15-8:30 p.m. (Fleming).

**GSG**, Daventry, England, 17,790 kc., 5-6 p.m. (Patrick); daily 12:15-6 p.m., 9-11 p.m. (Welper, Wollenschlager, Oglesby, Diez, Partner, Dressler, Allison).

**GSI**, Daventry, England, 15,260 kc., daily 12:15-4 p.m., 9-11 p.m. (Welper, Wollenschlager, Diez, Partner, Dressler).

**GSJ**, Daventry, England, 21,530 kc., daily 9:15-12 a.m. (Dressler).

**DJB**, Zeesen, Germany, 15,200 kc., daily 4:50-10:45 p.m. (Alfred, Welper, Lander, Myers, Wollenschlager, Dressler, Coover, Fleming).

**DJD**, Zeesen, Germany, 11,770 kc., daily 4:50-10:45 p.m. (Alfred, Welper, Harley, Lander, Myers, Wollenschlager, Dressler, Coover, Fleming, Black).

**DJL**, Zeesen, Germany, 15,110 kc., daily 4:50-10:45 p.m. (Alfred, Welper, Wollenschlager, Nigh); daily 2-4:30 p.m. (Dressler, Allison).

**DJQ**, Zeesen, Germany, 15,280 kc., daily 4:50-10:45 p.m. (Alfred, Welper, Lander, Wollenschlager, Dressler); daily 6-12 a.m. (Fleming).

**DJO**, Zeesen, Germany, 11,790 kc., 8:15-8:45 p.m. (Harley); signed 7 p.m. (Welper).

**DJR**, Zeesen, Germany, 15,340 kc., 4:50-10:45 p.m. (Welper, Dressler).

**DIP**, Zeesen, Germany, 14,410 kc., 4:50-8:45 p.m. (Alfred).

**DZG**, Zeesen, Germany, 15,360 kc., signed 3:45 p.m. (Welper).

**DZE**, Zeesen, Germany, 12,130 kc., Wednesday 1-4 p.m. (Westman).

**RAN**, Moscow, U. S. S. R., 9595 kc., daily 7-9:15 p.m. and Monday, Friday and Saturday 4-5 p.m. (Alfred, Patrick, Black, Welper); 11:30-12 p.m. (Fleming, Myers, Partner, Wollenschlager, Unger, Dressler, Markuson).

**RNE**, Moscow, U. S. S. R., 12,000 kc., daily 7-9:15 p.m. and Monday, Friday and Saturday 4-5 p.m. (Alfred); Thursday 4-5 p.m.

IN LITTLE OLD N. Y.

*Picture below is Observer Herman Ruppert, of New York City, tuning in one of his numerous receivers in his DX corner. Notice the prized L.P.O. certificate framed on the wall.*



**COSTA RICA'S NEW STATION**  
*Observer Lee Meade Williams sends us in another "first" in the form of this verification of TILS.*

(Myers, Shamleffer); daily 11 p.m.-2 a.m. (Fleming).

**RKI**, Moscow, U. S. S. R., 7500 kc., daily 7-9:15 p.m. and on 15,090 kc. (Alfred); 15,000 kc.—“This is Moscow Calling” (Welper); 7518 kc. (Partner, Dressler).

**RAG**, Moscow, U. S. S. R., 12,150 kc., irregularly 10:15-11:30 p.m. (Alfred).

**CSW**, Lisbon, Portugal, 9930 kc., daily 6-8 p.m. (Alfred); 11,040 kc., 12-4 p.m. (Partner); 9940 kc. (Dressler, Westman, Shamleffer, Markuson).

**CT1AA**, Lisbon, Portugal, 9650 kc., Tuesday, Thursday and Saturday 3:30-6 p.m. (Alfred, Welper, Unger); 11,830 kc. (Ruppert, Atherton, Westman, McKenzie, Fleming, Shamleffer). Slogan: “Radio Colonial,” cuckoo call used. Address: Av. Antonio Augusto d’Aguar, 144, Lisbon.

**OLR4A**, Prague (Podebrady), Czechoslovakia, 11,840 kc., daily 2:30-4:30 p.m., Thursday 8-10 p.m. (Alfred); 7:10-7:50 p.m. (Patrick, Welper); signs Sunday 5:15 p.m. (Fleming); Monday and Thursday 7-9:10 p.m. (Lander, Myers, Unger, Murray, Shamleffer).

**OLR5A**, Prague, Czechoslovakia, 15,230 kc., Thursday 8-10 p.m. (Alfred); daily 2-2:15 p.m. (Noyes, Welper); Monday 8-10:15 p.m. (from veri) (Markuson).

**OLR3A**, Prague, Czechoslovakia, 9550 kc., Thursday 8-10 p.m. (Alfred).

**TFJ**, Reykjavik, Iceland, 12,235 kc., Sundays only, 1:40-2:30 p.m. (Alfred, Myers, McKenzie, Fleming, Shamleffer).

(Turn to page 418)











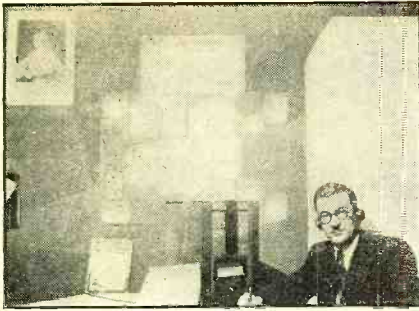

## The DX Corner (Short Waves)

(Continued from page 415)

**PCJ**, Huizen, Holland, 9590 kc., Sunday 7-9:10 p.m., Wednesday 7-10 p.m. (Alfred); Tuesday 1:30-3 p.m. (Welper, Wolien-schlager, Pierce); 15,220 kc. (Dressler, Unger); Tuesday 4:30-6 a.m., 15,220 kc. (Shamleffer); Sunday 2-3 p.m. (Markuson, Gallagher, Coover, Fleming, Black, Shamleffer).

**PHI**, Huizen, Holland, 11,730 kc., 9-12 p.m. (Gallagher, Coover, Fleming, Dressler); 11,740 kc. (Shamleffer).

**HAT4**, Budapest, Hungary, 9125 kc., Wednesday and Sunday 7-8 p.m. (Alfred); 6 p.m. (Nigh, Unger, Dressler, Cindel, Fleming, Shamleffer).

**HAS3**, Budapest, Hungary, 15,370 kc., Sunday 11-12 a.m. (Smith); Sunday, 9-10 a.m. (Unger).

**LKJ1**, Jeloy, Norway, 9520 kc., daily 5:15-8 a.m. and 11 a.m.-5 p.m. (from veri) (Smith, Ruppert).

**SM5SX**, Stockholm, Sweden, 15,155 kc., irregularly (Smith, Millen); daily 11 a.m.-5 p.m. or later (Partner); on all day Sunday (Wilson).

**SBO**, Stockholm, Sweden, changed from SBG, 3 p.m. (McKenzie, Birnie).

**LZA**, Sofia, Bulgaria, 14,940 kc., daily from 4 p.m. (Betances, Scala). Address: Maskovska, Rue 19, Sofia.

**OZF**, Skamlebaek, Denmark, 9520 kc., replaces OXY (N. C. Smith); 2-4 p.m. (Beard, Eder); 4-7 p.m. (Partner).

**OER2**, Vienna, Austria, 11,800 kc., Monday and Friday 10 a.m.-5 p.m. and Saturday 10 a.m.-6 p.m. (Ruppert).

**SPW**, Warsaw, Poland, 13,635 kc., Sunday 11:30 a.m.-1:30 p.m. (Partner); Sunday 6-8 p.m. and week days 6-7 p.m. (McKenzie).

**I2RO3**, Rome, Italy, 9635 kc., 6 p.m. (Welper); Thursday and Saturday 6-7:45 p.m. (Cindel).

### OUR POLISH OBSERVER

*Mr. M. P. Piorko poses for a picture in Poland. Plenty of P's in this caption, but then again Observer Piorko watches his P's and Q's when sending in his very accurate short wave reports.*

### Africa

**EAJ43**, Tenerife, Canary Islands, 10,370 kc., daily 2-4 p.m., 4-6 p.m., 7:20-7:55 p.m., 8-9:45 p.m. (Neuerbourg); relays **EAS8B** (Westman, Alfred, Fleming, Shamleffer). Address: P. O. Box No. 225.

**EA9AH**, Tetuan, Spanish Morocco, 14,030 kc., 4:45-5:30 p.m. (Smith); daily 7-9 p.m., works amateurs after 9 p.m. (Alfred, Fleming); 5-6 p.m. (N. C. Smith); 14,004 kc. (Shamleffer, Diez).

**VQ7LO**, Nairobi, Kenya Colony, Africa, 6082 kc. (Millen); Saturday 8:15 p.m. (N. C. Smith).

**CR7BH**, Lourenzo Marques, Mozambique, 11,718 kc., daily 10:30 a.m.-12:30 p.m. (Pierce).

**ZTJ**, Johannesburg, Transvaal Protectorate, South Africa, 9650 kc., schedule: Monday, Thursday and Friday 11:45 p.m.-12:30 a.m., 3-7 a.m., 9 a.m.-4 p.m., Saturday the same except last time is 8:15 a.m.-4:45 p.m., Sunday 4-4:45 a.m., 8 a.m.-3:15 p.m. (Van Os); bugle calls used, 9620 kc. (announced frequency is 9650 kc.), reports requested, announce in English (Gallagher); 6097 kc. (Markuson). Address: P. O. Box No. 4559.

**ZNB**, Mofeking, South Africa, 5900 kc., Monday through Friday 1:15-2 a.m., 1-9:30 p.m., Sunday 1-2:30 p.m. (Wilson). Address: Bechuanaland Protectorate, So. Africa.

### Oceania

**VK6ME**, Perth, Australia, 9590 kc., daily 6-7:30 p.m. (Alfred); daily except Sunday 5-8 a.m. (Fleming, Gertenbach). Address: c/o Amalgamated Wireless Ltd.

**VK3ME**, Melbourne, Australia, 9510 kc., signs daily except Sunday at 7 a.m. (Noyes, Welper); 9500 kc., daily 6-7:30 a.m. (Alfred); daily 4-7 a.m. (Myers, Lindner, Fleming, Dressler).

**KZRM**, Manila, Philippine Islands, 11,840 kc. (Millen); 9570 kc., 1:30-2 a.m. daily (Pierce).

**VPD2**, Suva, Fiji Islands, 9540 kc., signs daily at 7 a.m. (Noyes,

### WHERE IS "TOLPIN"?

*Observer Samuel Tolpin is missing! Letters addressed to him have never been answered. Does any one know if he has moved and if so where to? The photo at the right was taken of his DX corner in 1935.*

Welper); daily 6-7 a.m. (Alfred, Lander); 15,165 kc. (Partner).

### Asia

**JZK**, Nazaki, Japan, 15,160 kc., daily 3-4 p.m., 4:30-5:30 p.m., signed with music and gong, Sunday 9:30-10 a.m. (Welper); 12:30-1 a.m. and 8-9 a.m. (Alfred); daily 12:30-1 a.m. (Smith, Chadwick, Markuson, Wollenschlager, Neuerbourg, Mott, Shamleffer, Black).

**JZJ**, Nazaki, Japan, 11,800 kc., daily 8-9 a.m., 3-4 p.m. and 4:30-5:30 p.m. (Welper, Alfred); daily 12:30-1:30 a.m. (Smith, Chadwick, Myers, Neuerbourg, Pierce, Lindner, Fleming). Slogan: "The Voice of Tokio."

**JVN**, Nazaki, Japan, 10,660 kc., daily 3-7:30 a.m. (Welper); 4:30-5:30 p.m. (Alfred, Watson, Pierce, Diez, Dressler).

**JVO**, Nazaki, Japan, 10,370 kc., Thursday 7-8 a.m. (Myers).

**JFAK**, Taiksku, Japan, 9600 kc., 8:30 a.m. (Eder).

**JIB**, Taiwan, 10,530 kc., daily 2:10-3:15 a.m. (Pierce); signed 7:40 a.m. (Lindner, Gallagher).

**PLP**, Bandoeng, Java, 11,000 kc., daily 5-10 a.m. (Welper, Alfred, Pierce, Gallagher, Fleming, Black).

**PLY**, Bandoeng, Java, 9415 kc., 6-7:30 a.m. (Alfred, Gallagher, Black).

**YDB**, Soerabaja, Java, 9550 kc., daily 6-10 a.m. (Fleming, Gallagher); daily 6-7:30 p.m. (Markuson).

**HS8PJ**, Bangkok, Siam, 19,020 kc., Thursday 8-10 a.m. (Westman); Monday 8-10 a.m., 19,020 kc., and Thursday 8-10 a.m., 9510 kc. (Partner, Sakely, Pierce, Pairman, Gallagher, Black).

**ZBW3**, Hong Kong, China, 9610 kc. (Lander, Diez); 9525 kc., daily 5-9 a.m. (Fleming).

**XGOX**, Nanking, China, 9800 kc., daily 12-3 a.m. (Pierce, Gallagher).

(Turn to page 442)





# The A, B, C's of ANTENNAS

## (Impedance Matching)

By I. Queen  
Part Two

IN the last installment, the author explained how antennas operate. This month, he starts an explanation of the all-important factor of "matching" to obtain maximum efficiency from the antenna.

THE impedance of an antenna or any circuit can be considered its a.c. resistance. It is the ratio of the effective a.c. voltage to the effective alternating current. It depends upon the resistance and the reactance present in the circuit. For instance, at the ends of a Hertz antenna we have points of high impedance, for the ratio of its voltage to its current is almost infinite. Likewise, at the center of a half-wave Hertz we have a point of very low impedance because of the low ratio of voltage to current.

### Matching Impedance

It is well-known that in a d.c. circuit, power is most efficiently transferred from a source to a load when the resistance of the load equals that of the source. This principle of "impedance matching" appears often and should be well understood. For those acquainted with the elements of differential calculus we have the following proof of this principle. In Figure 1,  $R_L$  is the resistance of the load,  $R_B$  the resistance of the source, and  $E$  the applied load.  $W$  is the power in the load.

$$I = \frac{E}{R_B + R_L} \quad W = \frac{E^2 R_L}{(R_B + R_L)^2}$$

$$\frac{dW}{dR_L} =$$

$$\frac{E^2(R_B + R_L)^2 - (E^2 R_L)(2)(R_B + R_L)}{(R_B + R_L)^4}$$

$$= \frac{E^2(R_B - R_L)}{(R_B + R_L)^3}$$

When the differential coefficient of  $W$  with respect to  $R_L$  is zero, we have a maximum in the variation of

output power with respect to  $R_L$ . This happens when the numerator of the last equation becomes zero:  $E^2(R_B - R_L = 0$  or  $R_B - R_L = 0$  and  $R_B = R_L$

The resistance of the load should equal the resistance of the source for maximum transfer of energy.

For those who cannot follow the above reasoning, we have these considerations. Let us take the case of an automobile climbing up a hill. The car can always produce a certain amount of power. On a horizontal surface we would seldom use low gear. More power can be obtained by using high gear. In climbing the hill, however, we are forced to use low gear to accomplish maximum results. We simply "match impedances" in both cases. We can either have great speed and low lifting force or low speed and great lifting force. We cannot have both because the energy available is assumed constant.

### Familiar Analogy

Let us examine Figure 2. Here we have a channel A filled with water opening suddenly into another channel B. If we start a wave in A we will find that on reaching the channel B it will become of much smaller amplitude and another wave is started back or reflected. Likewise, if a wave were started in B, it would travel into A but at the junction a reflection would again take place, and it would be impossible to obtain a maximum wave. Only when the two channels are of equal width or "impedance" will the wave travel on without reflection, so that more energy will be transferred from source to load.

In the same way, electrical energy has two components; voltage and current. A source of power might have available a (Turn to page 440)

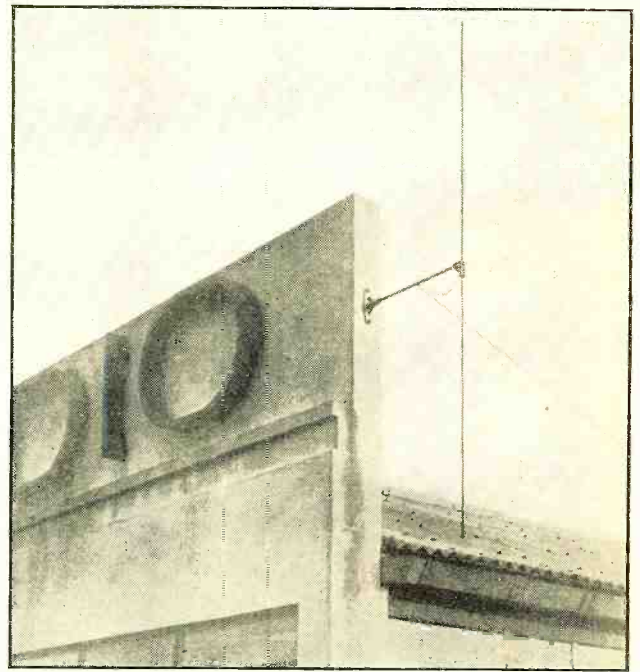

SOON TO BE SEEN ON EVERY HOUSETOP?  
This is the Belling-Lee Antenna now in wide use in England for reception for pictures. Radio dealers, servicemen, amateurs, and experimenters should learn something about installation of such equipment to be ready when television starts commercially in the U. S. A.

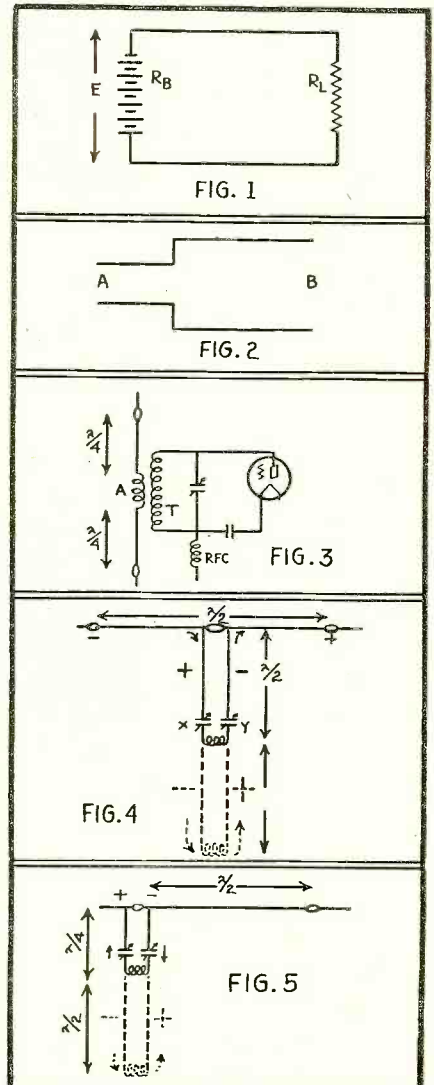



---



---

# RADIO NEWS INDEX

---



---

VOLUME XIX, NUMBER 1	July, 1937	Page	VOLUME XIX, NUMBER 4	October, 1937	Page
Index for January to June 1937 issues.....		5	New Broadcasting Stations.....		199
Television Advances (RCA Empire State Transmitter).....		7	Building the Pocket Sportset.....		202
Symposium on Inter-Office Call Systems.....		10	Television Range Extended.....		203
Using an Oscilloscope in Auto-Radio Servicing.....		13	The Radio Beginner (Part 14) (A.C.-D.C. Set).....		204
How to Build a V.T. Voltmeter.....		14	Electronic Signal Mixer.....		205
Opportunities for Television Operators.....		15	The "Ham Shack" (Operating the All-Band Transmitter).....		206
Designing Resistance-Coupled Amplifiers (Part 2).....		16	5-Meter U-Beam Antenna.....		207
Pre-Amplifier for P.A. and Ham Work.....		18	Crystal Control 10-20 m. one kw. transmitter (Part 3).....		208
P.A. Equipment for the Summer Market.....		19	10-160 Meter Transmitter (Montgomery Ward model OR-5).....		211
The "Ham Shack" (Erecting Antennas).....		20	The Radio Workshop.....		212
Bishop 5-Meter Converter.....		22	Design Features of the Silver Masterpiece VI Receiver.....		213
Special DX Antennas.....		23	The "Tiny Tot" Portable Mobile Transmitter.....		214
Testing RCA model ACT-20 Ham Transmitter.....		24	Inter-Office System Layouts.....		215
S.W. Station List (Americas, West Indies and Europe).....		25	Wien Bridge Frequency Meter.....		218
A "Closet-Door" Work Bench.....		33	Servicing Movie Sound (Part 3).....		219
The Radio Workshop.....		34	Testing the Scott "Philharmonic" Receiver (Part 3).....		220
The Radio Beginner (Test Oscillator) Part 12.....		36	Broadcast Station List (Asia, Africa, Australia).....		221
Revised Don Lee Circuit.....		51			
 			<b>VOLUME XIX, NUMBER 5</b> <b>November, 1937</b>		
<b>VOLUME XIX, NUMBER 2</b>	<b>August, 1937</b>		ABC's of Antenna Design (Part 1).....		263
Hard-to-Get Tube Data.....		71	U.H.F. Beam Antennas.....		266
Receiving Tube Charts.....		73	A Black-Light Burglar Alarm.....		268
Automatic Ship-to-Shore Radiophone.....		77	The Radio Voter (Dr. N. M. Hopkins device).....		269
Tube Base Chart.....		78	Building the Meissner Communication 14 Receiver (Part 1).....		270
Transmitting Tube Charts.....		80	Building a Neon-Tube Audio Oscillator.....		274
Receiving Tubes in Transmitters.....		82	Mobile Sound Systems.....		275
Description of Scott "Philharmonic" Receiver.....		83	Servicing Movie Sound (Part 4).....		276
Radio Balloons Report Weather Facts.....		84	Description of Midwest VT-20 Receiver.....		277
"Robot" Receiver for Cargo Vessels.....		85	The "Ham Shack" (Choosing A Crystal Oscillator).....		278
Servicing Movie Sound (Part 1).....		87	Super with a Full-Vision Tuning Dial (National NC80X).....		279
How to Build a V.T. Voltmeter (Part 2).....		88	Hallicrafter's "Skyrider" 11-Tube Receiver.....		280
Kelley Push-Pull D.C. Amplifier.....		89	Testing 10-160 M. Transmitter (Montgomery Ward OR5 Part 2).....		281
The "Ham Shack" (Antenna Relays).....		90	Installing the "Tiny Tot" Mobile Rig.....		282
Harvey Mobile UHX10 Transmitter.....		91	Crystal Control 10-20 M. one kw. transmitter (Part 4).....		284
Crystal Control 10-20 M. one kw. transmitter (Part 1).....		92	Design Features of the Silver Masterpiece VI Receiver (Part 2).....		285
The Radio Workshop.....		94	The Latest "Super-Pro" for the Home (Hammarlund Console).....		290
S.W. Station List (Africa, Asia, and Oceania).....		101			
 			<b>VOLUME XIX, NUMBER 6</b> <b>December, 1937</b>		
<b>VOLUME XIX, NUMBER 3</b>	<b>September, 1937</b>		How Soon Television?.....		327
Starting a Service Career.....		135	Checking the Midwest VT-20 Receiver.....		329
Symposium on Midget Cathode-Ray Oscilloscopes.....		138	The Latest Trends in Push-Button Tuning.....		330
Servicing Movie Sound (Part 2).....		142	Calibration of Test Oscillators.....		334
RCA Demonstrates Big-Screen Television.....		143	Kelley D.C. Amplifier with Inverse Feedback.....		336
The "Ham Shack" (10-160 Meter Transmitter).....		144	Servicing Movie Sound (Part 5).....		338
Description of Patterson PR-15 Receiver.....		145	Learning the Code.....		339
Crystal Control 10-20 M. one kw. transmitter (Part 2).....		146	The "Ham Shack" (Curing BCL Interference).....		340
Jarnak Acoustical Headphone Labyrinth.....		149	Voltage Supply for the Velotron Microphone.....		341
Operating Tests on RCA model ACR-111 Receiver.....		151	"J" Antennas for the Ultra-High Frequencies.....		342
The "Tiny Tot" Super-Regen Receiver.....		152	Test Report on Meissner Communication "14" Receiver (Part 2).....		344
The Radio Beginner (A Superhet Tuner) Part 13.....		154	The R.N. Progressive Transmitter (Part 1).....		345
Air Programs Recorded.....		155	Checking the Silver "Masterpiece" VI Receiver.....		347
The Radio Workshop.....		156	R.N. "Skipper" TRF set for 2-Volt Tubes.....		348
Description of Scott "Philharmonic" Receiver (Part 2).....		157	Direct-Reading Modulation Meter (JMP model AM1).....		349
How to Build the 3-Band "Cruiser" Receiver.....		158	Air-Testing Hallicrafter's Super-Skyrider.....		354
			Vehicle Speaker Requirements.....		378





Reading the 'want-ads' in the hope of finding just any sort of a job—

Glamour and romance in Television-Broadcasting! An action scene "on stage" in the Power and Light Building, the home of Midland Television and the base of Midland's training.

**A Lifetime of Fear ? —OR— A GOOD JOB, MORE MONEY, for the FUTURE ? —OR— A BRILLIANT FUTURE in—**

# TELEVISION

**YOU CAN BE ONE OF THE VERY FIRST TO BE TRAINED ON "ULTRA-MODERN," 441-LINE ELECTRONIC TELEVISION EQUIPMENT**

**BROADCASTING — AIRLINE OPERATING SHIP OPERATING POLICE RADIO**

Sound advice. Based on ironclad facts! If that's what you want, read on. But if you're looking for the easy, "gambling way" of winning success, you might as well stop reading right now.

This very minute you're confronted with opportunities of such magnitude that you may be inclined to doubt their existence... Yet you know how Radio skyrocketed into a giant industry almost overnight. You know that many young men have won, and are continuing to win, success in Radio—**BECAUSE THEY TRAINED THEMSELVES FOR SUCCESS...** And now we all know that TELEVISION will be another world-wide industry, rich in rewards for those who are prepared... **WILL YOU BE READY?**... Yes, if you take immediate advantage of the outstanding features of Midland training!

Midland is the **ONLY** independent school offering complete, ultra-modern training on 441-line RCA electronic television receiving and transmitting equipment. And *that* is the type of equipment that is bringing commercial television closer every day. Already perfected to a point comparable to motion pictures, "electronic scanning" is almost ready to do its part in starting America on another era of prosperity.



Midland training includes actual experience as a Television Camera Man!

To take advantage of Midland's outstanding training, you don't have to give up your present job. You complete your preliminary training *at home*—studying intensely interesting "color-coded" lessons, conducting a host of fascinating and instructive experiments, with *equipment we provide*—and then you come to Kansas City and our beautiful home in the Power & Light Building for *actual experience*. For remember, this is **NOT** a correspondence course. It is a combined extension-resident training. You study actual operation of radio and television in our resident school, in our modern laboratories—under an engineering staff of accomplished, friendly men, with years of practical experience.

If you are sincere in desiring to enter an industry that offers immediate, substantial cash rewards and a brilliant future, we invite you to send for your **FREE** copy of "Fortunes in Foresight." Just fill out, clip, and mail us the coupon below. **DO IT TODAY AND WE WILL DO THE REST.**

**Full Transportation Allowance to Kansas City**



"... It was you who pointed out the vast possibilities of a radio career for me. It was Midland that made it possible."

*Orwin Middleton, employed by Earl J. Goetze, Inc., wholesale distributors RCA-Victor products.*

"... Thank you for obtaining my new position. Even though only part way through my course of study with Midland, I have already received much value for the money and time invested."

*Donald Welborn, employed by Radiolab, radio and public address sales, Kansas City, Mo.*



"... and I want to tell you and the whole wide world that I owe it all to your incomparable training and whole-hearted help!"

*Wm. Davis, Radio Operator with TWA, stationed at Amarillo, Texas.*

**Midland training prepares for TWO Government radio operator's license exams; qualifies for immediate employment in radio, and the marvelous future opportunities in television. As a Midland student, everything will be in your favor.**

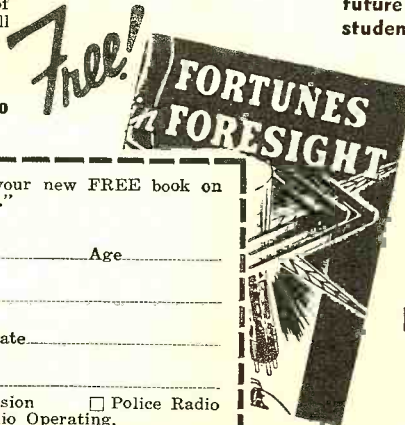

**MIDLAND TELEVISION, INC.**  
**Power and Light Building,**  
**110-A West 14th Street,**  
**KANSAS CITY, MISSOURI!**

*Affiliated with Columbia Network Basic Broadcast Station KMBC*

Gentlemen: Without obligating me, please send me your new **FREE** book on Radio-Television opportunities, "Fortunes in Foresight."

Name..... Age.....

St. or R. F. D.....

City..... State.....

Occupation.....

I am most interested in  Broadcasting  Television  Police Radio  
 Ship Radio Operating  Airline Radio Operating.  
 (Mail in envelope or paste on postcard)



# 25,000 OHMS PER VOLT

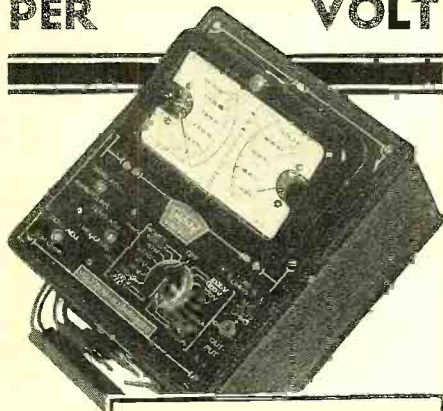

## Model 1200-E Volt-Ohm-Milliammeter

- Resistance Readings to 40 Megohms
- Separate A.C. and D.C. Instruments in Tilting Twin Case; Accuracy of Each Within 2%
- For All Radio Measurements Not Requiring a No Current Draw Vacuum Tube Voltmeter

Triplet Master Volt-Ohm-Milliammeter Easily Identified by the Exclusive Tilting Twin Instrument, Is by All Odds the Overwhelming Favorite . . . Because It Is the Most Practical. . . (It Offers the Most for the Money.)

Model 1200-E offers a new order of precision testing with 25,000 Ohms per Volt. Modern Radio sets that require delicate balancing can be easily and quickly adjusted.

READINGS: D.C. Volts 10-50-250-500-1000 at 25,000 Ohms per Volt. A.C. Volts 10-50-250-500-1000. 50 D.C. Microamperes, 1-10-50-250 Milliampere; Resistance 1/4-1000 Low Ohms, Backup Circuit; 0-40,000 Ohms; 4 and 40 Megohms.

A TRIPLET MASTER UNIT . . . one of a series of co-related single unit testers made in standard sizes, the most economical method yet devised for completely equipping the all-around radio service shop with high quality instruments. Catalog gives complete information regarding other Triplet Volt-Ohm-Milliammeters.

### New Laboratory Test Bench Panel As Shown Contains:

- 1210-A Tube Tester
- 1232 Signal Generator
- 1209-A A.C. Voltmeter
- 1209-D Volt-Ohm-Milliammeter

Model 1404



### Other Laboratory Models

Model 1402 with compartments for any two Master Units and one DeLux Tester.

Dealer Price. \$95.50 (complete less lamp)



### ELECTRICAL INSTRUMENTS

The Triplet Electrical Instrument Co.  
151 Harmon Dr., Bluffton, Ohio

Please send me more information on Triplet Model 1200-E . . . ; Model 1404 . . .

Name . . . . .

Address . . . . .

City . . . . . State . . . . .

## SERVICE — SALES

(Continued from page 401)  
one prong grounded to the chassis. I spotted the condenser okay, but the resistance was 12 ohms rather than zero. Measured directly across the condenser terminals the resistance was zero as it should be. This had me puzzled for a few minutes. As is common practice, resistors and condensers were grounded to bolts coming through the chassis—usually those which also hold the sockets in place. Upon measuring the resistance from these nuts or bolts to chassis, perceptible resistances were discovered—in one instance as high as 15 ohms. What had happened is obvious. In the course of time oxidation between the nuts, bolts and chassis increased the contact resistance. This increase of course would be negligible in the case of grounding a resistor (except for the possible introduction of noise). However, in the case of a condenser, the effect is to increase the power factor, and where this condition exists on several condensers in one set, the effect may be accumulative. I have improved the reception noticeably on several receivers through the simple expedient of eliminating this resistance. It is merely necessary to tighten the bolts. Even if already tight, the slight motion will be sufficient to break down the film.”—R. B., Scotia, N. Y.

### Belmont 540—A.C.-D.C.

This receiver is also sold by the Goodyear Service Stations under the name of “Wings.”

Howard J. Surbey of North Canton, Ohio, sends us a nice example of servicing with an oscilloscope. He writes: “This receiver was inoperative except on local stations. An attempt was made to secure a resonance curve on the oscilloscope by connecting the vertical plates to chassis and grid of the type 75 tube, and coupling a frequency modulated oscillator to the antenna circuit in the manner used for aligning. With the receiver volume on full and all gain controls on the oscilloscope also full on, the oscillogram shown in Figure 4 was obtained at the 1000-kilocycle setting of the dial. Various tests were made with the instruments operating in the above manner in an effort to increase the amplitude of this tracing. When the 25 mfd. condenser (C13 in the Belmont diagram) connected from the cathode of the 25Z5 tube to choke was shunted with a good condenser, the oscilloscope curve increased to such an extent that it exceeded the screen. After reducing the gain controls, the oscillogram shown

in Figure 5 was observed, and the receiver then operated in a fairly normal manner. The receiver was then aligned as outlined in the service manual, and the final overall resonance curve at 1000 kc is shown in Figure 6. The equipment used was a Triumph oscilloscope with a 3-inch tube and a Triumph wobblator.”

Stanley R. Covington—“Radio Service, Repairs, Parts, Supplies, Public Address Rentals—of Lynchburg, Va., sends us the following notes from his radio case book:

### Bosch

“United American Bosch, Model 502: Plays choo choo—whistles for every station. A shield plate soldered to the chassis and interposed between the 75 and 43 tubes was the remedy after everything else had been checked and found okay.

### Silvertone

“Chassis model 1954X. It squealed all over the dial. Only locals could be received, and at a moderate volume-control setting. All condensers checked perfect. The trouble was found to be a high resistance between the chassis and the tube shield bases—especially at the detector socket. The remedy is to solder the bases to the chassis.

### Majestic No. 70

“The field coil in the type G2 speaker burned out. The customer wanted the set now or sooner, and the proper coil was not available. A Victor R-32, 3000-ohms field coil served by employing only one cardboard washer at each end. The air gap between the coil and the core may be filled in with iron washers of the right size—but a satisfactory job can be had without them.”

### Arvin Home Radios

Oscillation and other effects caused by ineffective grounding of shield cans are prevalent sources of radio troubles today—as will be appreciated by the many relevant contributions to this department. E. Scribner of Schoharie, N. Y. sends in the latest: “The Arvin home radios have lugs on the shield cans that fit through the chassis for grounding. Make sure that the shields are in place—lugs through the chassis holes—and that everything is tight.”

### Zenith Going in for Television?

Chicago, Ill.—It is reported that profits for the Zenith Radio Corp. during August exceeded all company records for the month. A special meeting of stockholders, which was held on October 26th, was called in order to vote on charter amendments so as to include activities in television and facsimile apparatus.



## Lessons in Television

(Continued from page 396)

heat. One watt can, therefore, produce only from 8 to 12 lumens of light. If a standard candle lamp is placed in the center of a sphere with a radius of 1 ft. (diameter 2 ft.), the light will produce  $4\pi$  or 12.57 lumens on the inner surface of the sphere or 1 lumen every square foot of inside surface area—there being 12.57 sq. ft. in all. Since this would light 1 sq. ft. of surface at 1 ft. distance, it might be called a foot-candle (which is 1 lumen) the most common unit of light intensity measurement. Since the total light value is the product of the light source intensity, and the area on which it falls, we see immediately that for a small area the light density must be increased to preserve the same total or product.

Coming back to Figure 8, we have an audio amplifier which may be tuned as desired to 2400 cycles. A band-pass filter is used to cut off all frequencies below 1200 cycles and above 2600 cycles.

Here for the first time, we can see the necessity of the vibrating light modulator. It permits the amplification of a definite audio frequency whereas if we attempted to amplify only the wave produced by the graduations in tone of the picture the amplifier would not be as effective at some points on the picture as others. For example, if the tone of the picture changed only gradually from light to dark or vice-versa, each grid in the amplifying system would change just as gradually and the corresponding frequency would not be sufficient to pass through the coupling condensers. The 2400 cycle tone, however, will be amplified the same amount throughout the system and the system will handle this energy with any rate of modulation desired. Just as we found it necessary to use a high-frequency carrier to transmit voice currents through space, we may use a "carrier" (2400 cycles) to transmit what we will call the "picture component" through a wire and amplifier circuit.

### For Stronger Signals

Rochester, N. Y.—Mr. E. A. Hanover, Vice-President of the Stromberg-Carlson Telephone Mfg. Company, recently announced that station WHAM, NBC Blue Network affiliate, has under construction a self-supporting vertical antenna that will tower 450 feet into the air. The vertical radiator will be a 4-sided steel angle structure 25 feet at the base and tapering to a square 21 inches on a side.

# 417

## THINGS EVERY RADIO SERVICE MAN *Must Know!*



**Ghirardi gives you instant command of servicing essentials in 2 HANDY BOOKS**



**These Men Were Smart!**

They bought these two Ghirardi servicing books. Read what they say about them now:

"More data and information in these 2 volumes than a 4-year engineering course and always at your finger tips."  
—D. E. B. Marcellus, Mich.

"The tops in radio service information."  
—F. M. S., Crawfordsville, Ind.

"Like 1,000 hours additional experience."  
—J. M. H., Bad Axe, Mich.

"The best books in my collection. None better."  
—J. H. M., Lancaster, Pa.

"Had I purchased MODERN RADIO SERVICING before this time, I would not have had to invest all the money I did in other radio books with just half the information this 1 volume has."  
—R. C. P., Minneapolis, Minn.

You've got to know a lot to even "just hold-your-own" in the radio servicing game today. But you won't need to worry if you have MODERN RADIO SERVICING & RADIO FIELD SERVICE DATA at your elbow. These two great Ghirardi servicing books explain every phase of radio service work and will tell you exactly how to handle every servicing problem you'll ever run up against. The first book tells you HOW and WHAT—the other supplies instantly all the necessary receiver and servicing reference data right WHEN and WHERE you need it on a servicing job—with a regular Supplement Sheet service to keep it up to date at all times. This "double-barrelled combination" will give you both servicing "background" and "theory"—the "417 Essentials" of successful servicing—all clearly explained in easy-to-understand language. You need both of these books on your service bench right away. Together, they give you a total of 1800 pages of priceless servicing dope with 313 diagrams and illustrations to make everything perfectly clear—all for only \$6. You can't pass up this big Combination Offer. Grab it Now! Fill out the coupon below, and Mail it Today! Money-Back Guarantee. Sent Postpaid Anywhere!

### 1 TEST INSTRUMENTS

A 420-page section which gives you the whole theory and construction of every type of test and servicing equipment, with diagrams, construction data. "How-They-Work" descriptions of commercial models, etc., etc. Here's basic test-instrument knowledge for every service man.

### 2 TROUBLE-SHOOTING

254 pages of latest short-cut methods to use in analyzing all kinds of receiver troubles, AVC and QAVC circuits, tuning indicators, how to service circuits, etc.

### 3 REPAIR METHODS

184 pages of time-saving instructions for making the actual repairs in all types of receivers and individual components. How to align superhets by C-T Oscilloscope method. How to get rid of noise, electrical interference, intermittent reception, hum, distortion, etc.

### 4 SPECIALIZED SERVICING

442 pages of specialized servicing information covering Auto-Radio installation and servicing, All-Wave, High Fidelity, and Marine set servicing, Selling Service, etc.

### 5 CASE HISTORIES, etc.

The world's greatest collection of "Case Histories"—for over 1500 different receivers—in the Data Book. Also—the I. F.'s for over 8,000 superhets, Auto-Radio installation instructions for all cars, tube data, and 25 other invaluable charts and tables for instant reference in the shop or out on the job.



**MODERN RADIO Servicing and RADIO FIELD SERVICE DATA BOOK BOTH BOOKS—Only \$6**

To: Radio & Technical Publ. Co.  
Dept. RN-18, 45 Astor Place, New York

Here's \$6 for my copies of MODERN RADIO SERVICING and RADIO FIELD SERVICE DATA (with the Jan. and June '37 Supplements to Data Book) Postpaid. (\$6.50 foreign)

Please send me free descriptive literature about these 2 servicing books.

NAME.....  
ADDRESS.....

ow/  
**BALLAST REPLACEMENT**  
made **AMAZINGLY SIMPLE!**  
Only 4 standard types of Amperite AC-DC Regulators will replace 90% (over 100 types) of AC-DC Ballast Tubes now in use!  
WRITE FOR CHART AR.  
New Low Price \$1.00 List  
**AMPERITE** 361 BROADWAY, N. Y.  
**AMPERITE** AUTOMATIC REGULATORS

**SERVICEMEN! A CHANCE FOR EXTRA CHRISTMAS MONEY**

**TRIMM HEADSET ATTACHMENT**

—an ideal Christmas gift. Suggest this to your customers. For the short-wave fan and for bedside radios. Better reception without disturbing others. Special models for the hard of hearing.

**TRIMM RADIO MFG. CO.**  
1770 Berteau Ave., Dept. R-2  
Chicago Illinois

Don't Risk A Penny — Money-Back Guarantee Protects You! MAIL COUPON NOW!



# SOMETHING NEW UNDER THE SUN



## A COMPLETE TUBE COMPLEMENT BOOK

Of course there have been tube complement books before. But when you find one as full of helpful information as is the big, 200-page Sylvania Tube Complement Book—that's something new!

Take a look at this list of features:

1. Tube complement listings for 10,386 models.
2. Complement listings for 259 companies.
3. Largest compilation of i.f. peaks available today.
4. Contains helpful articles on tube selling, etc.
5. Largest compilation of trade names ever made—560 names.

That's all we have room to mention here. But there are many more features—all designed to be of help to you.

Where "under the sun" can you find a complement book as complete as this one? And the price is only a quarter!

See your jobber, or rush the coupon and 25c to us. You'll get your copy of the Sylvania Tube Complement Book in a few days.

# SYLVANIA SET-TESTED RADIO TUBES

HYGRADE SYLVANIA CORPORATION  
Emporium, Pa. RN-19

Enclosed please find 25c. Send me my copy of your new Tube Complement Book right away.

Name .....

Address .....

City ..... State .....

Dealer       Service Man

Amateur       Experimenter

# RADIO PHYSICS COURSE

ALFRED A. GHIRARDI

## Lesson 69. Meters

**U**SE of ammeters: From the foregoing chapter it is evident that a d. c. ammeter really consists of a portable type of D'Arsonval galvanometer with a suitable shunt connected across it, and a scale calibrated in amperes. The fine wire on the movable coil only carries a definite small fraction of the total current, which is being measured.

Ammeters are used in all branches of electrical work and are designed to measure small currents of a few thousandths of an ampere (milliampere) as well as currents of thousands of amperes. In radio work, low reading ammeters are commonly used to measure the currents in the filament circuits of the vacuum tubes. Ammeters used to measure the plate currents of these tubes are called *milliammeters* (one milliampere equals 1/1000 ampere), because their scales

range of a d. c. ammeter or milliammeter on hand, in order to save the cost of a new instrument of larger range. This may be done by connecting an additional shunt resistor across the terminals of the meter to shunt a portion of the total current around it. Thus consider in (A) of Figure 1, that the meter on hand (whether it already has a self-contained shunt in it or not does not make any difference) has a range of 0-1 milliamperes. Suppose we want to extend its range to 10 m.a. Then a shunt  $R_s$  must be connected across it such that the moving coil of the meter will carry 1/10 of the total current and the shunt 9/10, or the shunt resistance will be 1/9 of the meter resistance. If the meter resistance is 27 ohms for instance, the shunt resistance required to make a 0-10 milliammeter of it would be,  $1/9 \times 27 = 3$  ohms.

In general let us suppose the meter

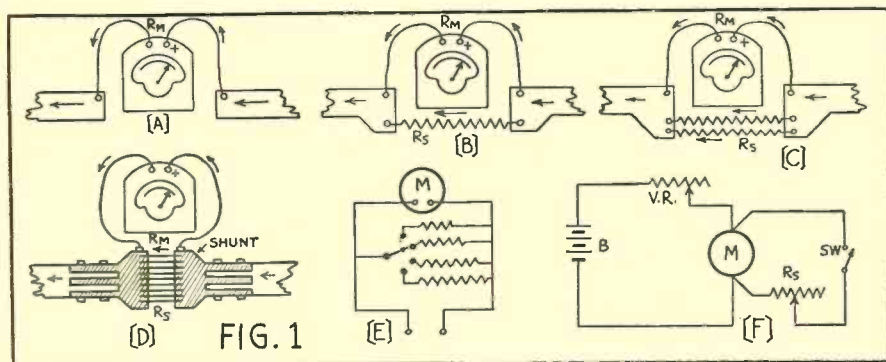

Figure 1. How shunts are connected to carry a definite fraction of the total current in a circuit, permitting the use of an ordinary galvanometer movement as an ammeter to measure large currents.

are marked to read the current in milli-amperes. The only difference between a d-c ammeter and d-c milliammeter is in the size of the shunt employed.

The ammeter or milliammeter must *always* be connected in *series* with *either* side of the line, as shown at (A) of Figure 1. When connecting an ammeter in a circuit, it is necessary to open one side of the line and connect the ammeter so the current flows *through* it. The instrument should have a range sufficiently high to carry the current flowing. Remember that the ammeter must always be connected in *SERIES* with *one side* of the line. Never connect an ammeter *across* the line, for since it has a very low resistance, the e.m.f. across the line would send a heavy rush of current through it and burn it out.

It is often desired to increase the

considered has a resistance of  $R_m$  ohms and let  $R_s$  be the resistance of the additional shunt to be connected across it to increase its range. Let  $I_m$  be the original maximum scale reading (in amperes or milliamperes) of the instrument. Let  $I$  be the desired new maximum reading (correspondingly in amperes or milliamperes). Then:

$$\frac{I}{I_m} = N = \text{multiplying factor.}$$

$$\text{and } R_s = \frac{R_m}{N-1}$$

Example: A milliammeter having a range from 0-50 milliamperes and an internal resistance of 2 ohms, is to be converted into an ammeter having a maximum range of 10 amperes. What value of shunt resistor must be connected across its terminals?

Solution: 10 amperes = 10,000 milliamperes.



$$\text{therefore } N = \frac{I}{I_m} = \frac{10,000}{50} = 200$$

$$\text{and } R_s = \frac{R_m}{N-1} = \frac{2}{200-1} = .01 \text{ ohm}$$

(approximately) Ans.

Thus a shunt resistor of .01 ohm must be connected across the meter. This should be of a size able to carry the current without undue heating. All readings as read on the old scale of the meter must now be multiplied by the multiplying factor N, (200 in this case) to obtain the correct reading in milliamperes.

A number of shunts may be connected across a meter and controlled by a low resistance contact switch, so that any one of them may be put in the circuit at a time. This arrangement is shown at (E) of Figure 1.

It is evident from the above problem, that in order to calculate the value of  $R_s$  by this method, the exact value of the internal resistance of the meter must be known. This information can be obtained from the manufacturer of the meter. The resistance of most small 2-inch and 3-inch diameter type milliammeters is in the neighborhood of 20 to 50 ohms.

### Serviceman's Diary

(Continued from page 388)

with the set?" (I didn't have one.) It needed a new volume control also so I managed to corral the job anyhow. When I return, it will have to be the last call for the day as she will be gravely insulted if I don't taste her high-power wine. Well, it's all in the game.

Stopped off to look over an aerial job. Of course, on a busy Saturday afternoon we can't take the time to put in a first-rate installation of a noise-reducing system (but if we tell a customer that over the phone, we lose the job). The old antenna was dragging in the driveway, so I cut it off close to the house, then checked the set. Made a survey and some rather unnecessary measurements to determine the location and amount of lead-in wire needed, then postponed the antenna job until next week, having done just enough work (I hope) to hold the job for the time being.

### Big Export Market for P. B. Sets

Chicago, Ill.—"Automatic Tuning is bound to be popular in foreign countries," says Art Maybrun, Export Manager of Travler Radio & Television Corp. Mr. Maybrun finds that foreign markets are most favorable to tuning features, and it is his strong opinion that this year's American-made sets with their automatic tuning features will have very definite foreign appeal.

# ALLIED

Presents  
**RADIOS NEWEST FEATURES**  
**AT LOWEST PRICES!**  
*in 61 New Knight Radios*

ALLIED leads again in value with 61 new Knight Radios combining radio's newest features at the season's lowest prices. Advanced R. C. A. and Hazeltine licensed circuits, with Electric Push-Button Tuning—a station a second, Select-O-Matic Dials, the Electric Eye, Automatic Frequency Control, Full Voice Speakers—broadcast Studio tone quality, world-wide range—all these features and many others at prices that challenge the industry. From 5 to 16-tube models—for AC, AC-DC, 6-volt, 32-volt, battery and auto operation. ALLIED's volume and low distribution costs make Knight radio's greatest values, offering biggest profits for you. See all models in ALLIED's great 1938 Catalog.

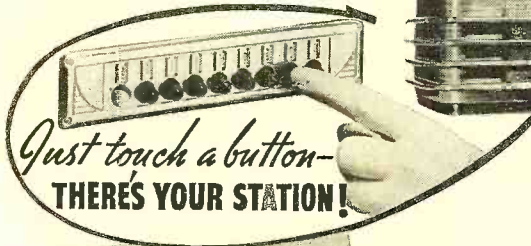
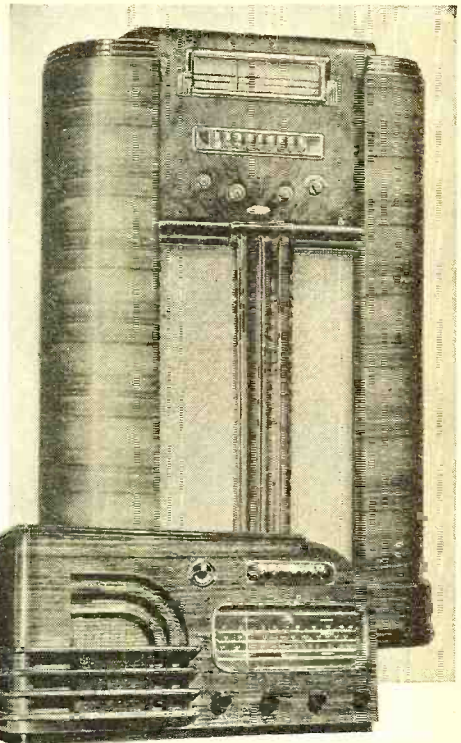

**KNIGHT 11-TUBE**  
Push Button Tuning—  
All-wave. ONLY... **\$58.95**

**KNIGHT 6-TUBE**  
Push-Button Tuning  
3 Bands. ONLY... **\$28.85**

### EVERYTHING IN RADIO AT LOWEST PRICES!

Whether you're a Dealer, Service Man, Sound Specialist or Amateur-Experimenter, you need ALLIED's 1938 Catalog. It brings you everything you need in one great book—Parts, Kits, Sound, Amateur, Test Equipment, books, tools, accessories—every radio requirement spread before your eyes. ALLIED's complete stocks and fast service save you time—ALLIED's low prices save you money. Send coupon today for free copy of ALLIED's 1938 Catalog—radio's complete supply guide!

**KITS**  
**P. A.**  
**TESTERS**

ALLIED's Catalog offers over 12,000 parts—Builder's Kits (Write for free Parts List)—Sound Systems—Amateur gear, Test Equipment—all at lowest prices.

**FREE Catalog**

ALLIED RADIO CORPORATION  
Dept. 1-A8, 833 W. Jackson Blvd.  
Chicago, Ill.

Send your Free 1938 Catalog.  
 Send Free Parts Lists for...

Name \_\_\_\_\_  
Address \_\_\_\_\_ State \_\_\_\_\_  
City \_\_\_\_\_

**ALLIED RADIO CORP.**  
833 W. JACKSON BLVD., CHICAGO

### LEARN TO SEND AND RECEIVE **CODE**

Learn to send and receive code signals, like operators on ships at sea and at commercial and amateur land stations. Intercept distress signals, news flashes, bulletins, and dozens of other kinds of interesting radio communications.



**MASTER TELEPLEX** teaches you to receive code exactly the way the world's best operators do—by sound. A heavy waxed paper tape, running

through a machine, operates an automatic key which sends messages to you, at any speed you desire. As you improve in speed, the machine sends faster, gradually preparing you for top-speed amateur and commercial signals. With the new all Electric **MASTER TELEPLEX** you learn to send by sending and the signals you send are repeated back to you, exactly as you sent them, thus enabling you to correct your own errors. We furnish a complete course, lend you the improved All Electric **MASTER TELEPLEX** and give you personal instruction with a **MONEY BACK GUARANTEE**. Send for our new **TELEPLEX FOLDER R-N** today. IT'S FREE!  
**TELEPLEX CO., 72-76 Cortlandt St., New York**

Ask your **JOBBER**  
for the NEW

**STANCOR**

**"HAMANUAL"**

New Tubes... New Circuits

**16 NEW TRANSMITTERS**  
5 WATTS TO 1000 WATTS

**STANDARD TRANSFORMER CORPORATION**

850 BLACKHAWK STREET, CHICAGO



**POCKET SIZE...  
YET Precise!**

**WESTON**  
Model 697  
**VOLT-OHM-  
MILLIAMMETER**



ONLY  
**\$28<sup>80</sup>**

NET IN U. S. A.

Here's a convenient, pocket-size radio test instrument . . . but one that is made to the same standards of accuracy and dependability as the larger WESTON instruments. *Nothing has been sacrificed to achieve this small size.* The ranges provided, too, are complete for radio servicing:

Voltage Ranges: AC and DC—0-7.5; 0-15; 0-150; 0-750

Current Ranges: DC only 0-7.5 and 0-75 milliamperes

Resistance Ranges: 5000-500,000 ohms full scale; 35-3500 ohms center scale

Size: 5 1/8" x 3 3/4" x 3 1/8"

Model 697 is a most convenient tester to carry on service calls . . . a cinch to handle on the bench or around the shop . . . yet it is extremely low-priced for a sturdy, dependable WESTON instrument. Model 697 and other pocket-size WESTON testers should be included in every serviceman's kit. Be sure you have full information. Return the coupon today.

**WESTON**  
*Instruments*

Weston Electrical Instrument Corporation  
615 Frelinghuysen Ave., Newark, N. J.  
Send complete information on Pocket Size Testers.

Name \_\_\_\_\_

Address \_\_\_\_\_

City \_\_\_\_\_ State \_\_\_\_\_



## THE TECHNICAL REVIEW

CONDUCTED BY THE TECHNICAL EDITOR

*A Short-Wave Journey of Discovery*, by Hendrick Van Loon and Laurence M. Cockaday, RCA Manufacturing Co., Inc., 1937. Jointly the authors of this booklet have woven words into a magic carpet with which inexperienced owners of all-wave or short-wave receivers may explore with confidence the most fascinating regions of the radio spectrum. The old hand at dialing for distance will also find in this guide to short-wave listening a tabular co-ordination of the elusive facts concerning call letters, wave-lengths, program schedules and operating hours of all domestic and foreign short-wave broadcasting stations. A world map in colors showing time zones and locations of principal radio stations adds to the charm and effectiveness of "air-cruising" at any hour of the day or night. The booklet is illustrated by numerous line drawings executed in color in Hendrick Van Loon's inimitable style. National distribution of this publication is being effected through RCA-Victor dealers in principal cities and towns.

*Television*, Volume II, published by RCA Institutes Technical Press, 1937. A collection of addresses on the future of the new art and technical papers presented by members of the RCA engineering staff. Most of these technical papers are reprinted from the Proceedings of the IRE and from the RCA Review. All the lectures delivered at the IRE convention at New York City in May, 1937, are included. Within the 435 pages are 29 different articles dealing with the advances in television development. These include articles on kinescopes, iconoscopes, video amplifiers, ultra-short-wave transmission, etc.

*Wireless Servicing Manual*, by W. T. Cocking, third edition, Iliffe and Sons, London, England. This is a book intended for the British ser-

viceman with the aim of teaching the principles of operation of modern receiving circuits and the location of troubles. It is not intended to teach radio from the beginning, the reader is assumed to have acquired this knowledge already. Yet, there is considerable material dealing with the principles of operation and design since the author evidently believes that such knowledge will be useful to the serviceman in interpreting unusual conditions. The American reader will of course meet unfamiliar terms and diagrams, also, some subjects would seem to have extra emphasis while others are omitted. There is, for instance, a section on regeneration which is not employed in commercial receivers here. On the other hand, there is no mention of automobile receivers with their special problems and all-wave receivers do not seem to be considered. Otherwise, the reader will find much helpful information on such subjects as motorboating, tracing hum, aligning, a.v.c. etc.

*Automatic Frequency Control Systems*, by John F. Rider, published by John F. Rider. From the prolific pen of Mr. Rider comes another volume, this time dealing with the newest improvement—a.f.c. The volume begins with reviewing certain principles, which are utilized in a.f.c. circuits, then explains the workings of the discriminator and the corrector circuit. Then follow descriptions of commercial applications, alignment procedure and servicing. The text is written in the usual clear style of the author and should be a valuable addition to the serviceman's library.

*Tube Complement Book with I.F. Peaks*, published by Hygradesylvania Corp. The main body of this work contains a listing of commercial receivers by make and model number, giving the tubes required and the intermediate frequency. Be-



sides this list, there is a wealth of other useful information. A list of trade-names with their manufacturers, a list of addresses of active manufacturers, important data on equivalent tubes, on dial lights and modernization of sets with new tubes are among the other features.

**Review of the Proceedings of the Institute of Radio Engineers for October, 1937**

*A Negative-Grid Triode Oscillator and Amplifier for Ultra-High Frequencies*, by A. L. Samuel. Description of a new triode which oscillates and amplifies at frequencies higher than previously reported. The improvement is due mainly to the arrangement of the leads.

*Simple Method for Observing Current Amplitude and Phase Relations in Antenna Arrays*, by J. F. Morrison. A simple arrangement which is useful for verifying the correct antenna adjustment.

*Radiation from Rhombic Antennas*, by Donald Foster. A direct theoretical determination of the transmitting properties of the horizontal rhombic antenna and of the closely related inverted V structure. Expressions are given for the intensity of radiation, the polarization, the radiation resistance, and the gain.

**Review of Contemporary Literature**

**T**HE following are reviews of articles appearing in recent issues of technical magazines; the name of the magazine and its date are given after the title of each article. Copies of these articles are not included under the "Free Booklets"—they are available from your book-dealer or direct from the publishers. Addresses of publishers will be furnished on request.

*Sudden Disturbances of the Ionosphere*, by J. H. Dellinger, National Bureau of Standards Research Paper RP 1016. The results of a world-wide investigation of a sudden change in ionization of a portion of the ionosphere. It manifests itself by the complete fading out of h.f. radio transmission for a period of a few minutes to an hour.

*A Peak-Reading Power-Level Indicator for Monitoring Broadcast and Sound Recording Circuits*, by A. E. Thiessen, General Radio Experimenter, October, 1937. Description of a new instrument of wide range and employing an indicator with a very fast upswing but a slow down swing.

*A New I.F. Amplifier System with Infinite Off-Frequency Rejection*, by K. W. Miles and J. L. A. McLaughlin, QST, November 1937. This new coupling system combines capacitive coupling and inductive coupling in

(Turn to page 430)

# They're all in the New FREE 1938 CATALOG

The Winter Edition of our New 44-page Radio Catalog is an Encyclopedia on Standard Radio sets. It lists all the well-known makes in home electric sets—farm battery radios and auto radios; shows you all the newest 1938 models and gives you the features in each; such as Magic Voice with electric tuning in RCA-Victor; Robot dial, Acoustic adapter in Zenith; Inclined panel control for ease and grace in Philco; Touch tuning with 16 buttons in G. E.; Flash tuning, Acoustical Labyrinth in Stromberg Carlson; Teledial automatic tuning in Grunow; Transformerless AC circuit in Kadette; Quicktune dial in Crosley; and many other unusual features in these and other sets, too numerous to mention.

**Servicemen—Radio Salesmen—Agents**

With a marvelous catalog such as ours—it is very simple for you to earn \$100 or more weekly in commissions, by becoming a *MODELL* representative in your community. Our plan does not require any investment on your part. The many ways we assist you will help materially in developing and building up a permanent business of your own. Experience is not necessary, as our instructions give you all the help and ideas you will need to stimulate business in your locality. Men and women in cities, hamlets, farms, have found the *MODELL* plan so simple and effective, their letters of praise are pouring in daily.

**EASY PAY PLAN**

We have just added a new feature in our sales department. **THE EASY PAY PLAN**—by mail. You now can obtain any radio set for as little as \$5 down and the balance for as low as 50c weekly. You may take up to 20 months to pay.

Territory is now being allotted to full or spare time men. If you want an honest to goodness proposition, that will give you honest dollars, RUSH the coupon below for details and our big new Winter Edition of our 44-page 1938 radio catalog.

3-year written guarantee goes with each radio set

30-day free trial

## Modell's

Since 1889 DEPT. G-9

NEW YORK, N. Y.  
58 Cortlandt St.  
CHICAGO, ILL.  
56 W. Washington St.  
ATLANTA, GA.  
57 Forsyth St.

Mail Coupon Today

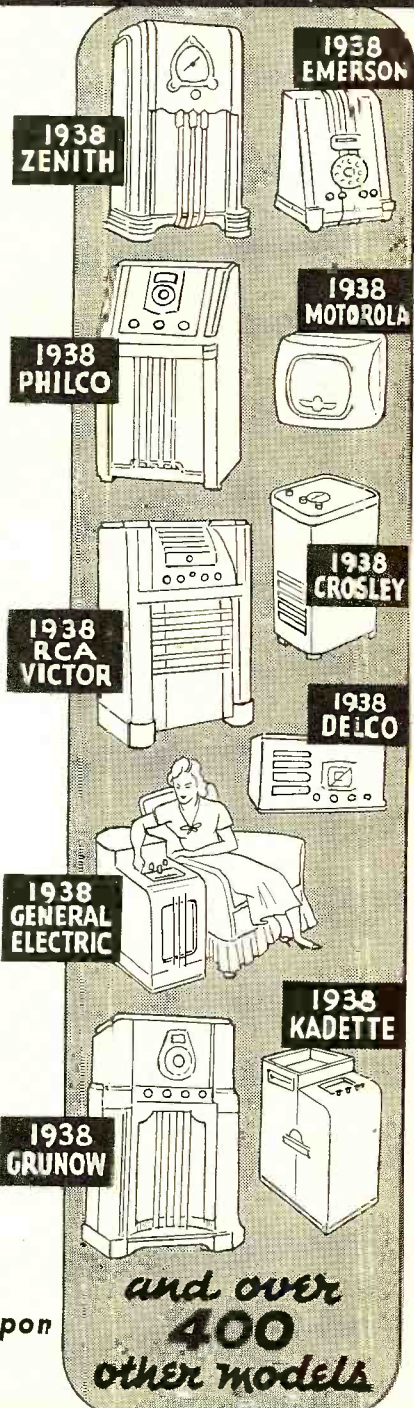

and over  
**400**  
other models





**MIDWEST...  
SAVES YOU 50%  
DIRECT FROM FACTORY**



**JUST TOUCH ONE BUTTON-  
NO NEED TO TURN CONTROLS  
ON THIS MOTORIZED MIDWEST**

**Only 49.95  
NEW LOW  
BASE PRICE  
CHASSIS**

**ONLY Midwest** gives you a combination of Mystic Movie Dial, Traveling Coloray Eye, and Motorized Tuning! Just touch a button on top of radio and FLASH!... your station comes in perfectly tuned, in 1/2 second. World-wide reception up to 12,000 miles brings in weak distant stations, like locals, and assure glorious, crystal-clear realism. Famous Midwest Factory-To-You plan enables you to buy at wholesale price... to save up to 50%... to enjoy 30 days' FREE home trial... pay as little as 50 cents a week. **Send for FREE 1938 Catalog** MIDWEST RADIO CORPORATION Dept. KK-11 Cincinnati, Ohio

**TERMS AS LOW AS 50¢ A WEEK**

PASTE COUPON ON POSTCARD - OR WRITE TODAY

**MIDWEST RADIO CORPORATION**  
Dept. KK-11, Cincinnati, O

Name \_\_\_\_\_

Address \_\_\_\_\_

Town \_\_\_\_\_ State \_\_\_\_\_

Send me your new FREE catalog, and complete details of your liberal 30-day Free trial offer. (Special offer and prices prevail only when dealing direct with factory by mail.)

User-Agents Make Easy Extra Money. Check Here  for details

Check Here for 1938 BATTERY catalog

**RADIO ENGINEERING**

**TRI-STATE COLLEGE**

**DEGREE IN 2 YEARS.**

Complete Radio Engineering Course in 96 weeks. Bachelor of Science Degree. Radio (television, talking pictures and the vast electronic field) offers unusual opportunities for trained radio engineers. Courses also in Civil, Electrical, Mechanical, Chemical, Aeronautical Engineering; Business Administration and Accounting. Low tuition, low living costs. World famous for tech-

# QRD? QRD? QRD?

CONDUCTED BY GY

**I**N a recent broadcast over the NBC network, Brother George Clark, former president of the VWOA (Veteran Wireless Operators Association), spoke on "The Human Side of Marconi." Stressing all the wonders of science this "true benefactor of mankind" had discovered, he invited all his listeners to contribute towards the erection of a fitting monument to him.

The Marconi Memorial Fund was launched under the auspices of the VWOA. Known as Veteran No. 1, Marconi was an honorary member of this organization. Brother McGonigle vividly remembers the time when Marconi was presented with a special gold medal by the VWOA. It was on December 12, 1931 at the worldwide broadcast celebration of the conquest of the Atlantic by wireless communication. Marconi then said, "I am deeply touched at having been presented with such a generous token of appreciation by the VWOA. . . . I wish to assure you that your valuable gift will be treasured amongst the most cherished awards I have ever received." For this great man the monument to him will be a living symbol of the esteem in which he was held by the American radiops and the world at large. David Sarnoff of RCA, McCosker of Mutual Broadcasting, and many others have already generously contributed. Donations may be sent to the Marconi Memorial Fund, 30 Rockefeller Plaza, New York. A committee of prominent members of the communications industry and the allied arts, many of whom worked side by side with Marconi during the early days of wireless, will pass upon a suitable design for this "living tribute" to Marconi.

The VWOA, the veteran organization of radiops, in a recent communication advises that the new officers installed for the coming year are: President, Bill McGonigle; Vice President, Fred Muller; Secretary, H. H. Parker; Treasurer, S. C. Simon. Radiops wishing to know more of this association which has no political affiliations, but is in line with all organizations having in their credo the betterment of the world, may do so by shooting their inquiries into this department. Among the activities include building monuments, handing out scrolls of honor and meritorious radiop work. The owner of the

Yacht ARAS (WBED), which was lying in the harbor of Hamilton, Bermuda, went into the radio shack one day taking a tack to starboard and four sheets in the wind, and declaimed on the vagaries of radio, "sparks," the Constitution, and the world in general. Then he says, "I've got a friend in Wellington, New Zealand. Here's a message for him." Sparks shifted to 36 Mtrs with his RCA s.w. 200-W output job and slashed the atmospherics with the call ltrs ZLB. Much to his surprise and delight, ZLB answered his first call with an R5. In twenty minutes he had a reply to the msg and the owner sobered up with the shock!

In a touching scene aboard the SS Yukon, last rites were held for our departed brother, Frank I. Hoseth, when his ashes were scattered over the Gulf of Alaska on the 26th of August, 1937. Fifty-three years old, Hoseth had followed the sea since he was fourteen and for the past 25 years had been employed as a radiop on various vessels of the Alaska SS Co. All who knew Frank are saddened by his untimely death. He was an excellent companion and shipmate for whom every one had a friendly word. May his soul rest in peace with Davey Jones.

Brass pounders who can't read English can now peruse Karl Baarlag's SOS To the Rescue in Dutch, German and Swedish. And the Congressional Library has a special Braille edition for the Blind. As this goes to press Ye Ed learns that Oxford Press is running off a fifth edition in anticipation of Xmas demands. Meanwhile the globe-trotting author heads south for Biscayne Bay and a winter in the Caribbean and Florida waters. Lucky dog, say we. Some times we wonder how much Karl's book had to do with the government's sudden tightening of American radio legislation after years of snoozing. Karl's book was read by President Roosevelt, Senator Wagner and many other bigwigs who initiate legislation. As one of the 136 reviewers cracked, "Karl has filed a mighty indictment against the Federal Government and against 'big business' . . . the reader, unable to lay aside the volume until it is finished, will note . . . the losses of lives in the sinking of the Titanic, the capsizing of the Vestris and the burning of the Morro Castle . . . could have been materially lessened but for . . . laws



antiquated . . . and for the penuriousness of the shipping owners who . . . profit . . . by failing to protect their passengers with radio equipment or by failing to employ relief ops for 24-hour use of required equipment." This book is not only an entertaining and enlightening adventure story, or series of stories, but, if properly publicized, will go a long way in remedying the very apparent evils in navigation laws and practices.

Ah, me. Again it comes to pass. Some of the boys on the trawlers up around Boston Harbor way are drawing down \$150.00 per month, plus \$6.00 per barrel for fish livers. Put together, it spells an average of almost \$190.00 per. But some of the radiops aren't satisfied with this arrangement and crave a flat rate of \$200.00 per month and a few other choice items. Now it came to pass that about a year ago on the good ship HECLA the skipper-owner had installed a phone Xmtr. And this skipper has been having the time of his life bellowing into the mike. He hasn't had any trouble with the equipment to speak of and works on schedule with the beach. Well, a few of the trawler owners got together and declared if the boys went on strike for the raise in pay, they'd rather install the phone equipment. And they've got the courage and money with which to do it! Now the question is: If there is a strike, who voted it? The men out of jobs on the beach or the radiops working on the trawlers?

Whilst sitting around the Buzzer Room of the CUT MARDIV in New York, Ye Ed noticed lots of action. Men coming and going, buzzin' and buzzin', paying dues and receiving instructions. And speaking of going, Brother Cosmas has been doing some tall traveling across the country. Using every means of transportation including the "confounded air contraction," he has hopped from New York to Chi, back to Boston to some-where else and thence to New Orleans. Yep, it's spreading out like a morning glory, growing and living. They're now putting out a small pamphlet-bulletin which will contain all the pertinent news of the organization and will be mailed to all members and to prospective members. They are taking larger space in their present building address to make room for their continual growth.

And as for Television, well, Brother David Sarnoff, who has just returned from England, states "The BBC has been operating its television Xmtr, located at Alexandria Palace in London, for about a year. The range is more than 25 miles and covers all of

(Turn to page 431)

# 6 REASONS WHY SUPREME VISUAL SERVICING WILL INCREASE YOUR PROFITS!



Model 546 3" Cathode Ray Oscilloscope. \$6.50 down — \$5.95 for 10 months. \$59.95 Cash Price.

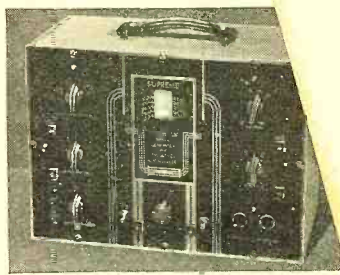

Model 581 Signal Generator \$6.00 Down—\$5.44 for 10 months on S. I. C. terms. \$54.95 Cash Price

ALL visual servicing is not alike! That's why you should demand proof of its accuracy and profit-making ability—before you buy!

Shown here are six profitable short-cuts that allow you to do service work more quickly, more efficiently! A few of the many dozens of instruments to which you can place SUPREME Model 581 Signal Generator and SUPREME Model 546 3" Cathode Ray Oscilloscope—the perfect instrument combination for Visual Servicing—use them both designed to work together!

The SUPREME 581 Signal Generator and Frequency Modulator gives you: Razor-Edge Tuning—Giant 340 degree dial—38 knob to condenser ratio—actual 8 feet scale length—125 KC to 60 MC on 8 bands can be used as (1) Unmodulated R. F. or (2) 400 cycle—30% amplitude band width frequency modulated R. F. or (3) 400 cycle amplitude modulated R. F. oscillator

modulated R. F. oscillator (3) 24 KC oscillator (for visual alignment) (4) 100 cycle oscillator (5) Fixed 400 cycle A. F. oscillator (6) Variable 60 to 10,000 cycle A. F. oscillator (7) Power supply frequency time base

Model 546 3" Cathode Ray Oscilloscope gives you:—(1) Lowest price complete 3" tube scope (2) 0 to 90,000 cycle linear vertical and horizontal gain controlled amplifiers (3) 15 to 30,000 cycle saw toothed linear time base (4) "Snap Lock" Synchronization circuit (5) Internal or external synchronization circuit (6) All controls including "Spot Centerers" on panel (7) D. C. or A. C. signal can be fed direct to deflecting plates. For the utmost in high precision, low cost, latest design and complete satisfaction, see SUPREME before you buy!

## HERE ARE THE 6 REASONS!

- 1. Visual Alignment**  
R. F. and I. F. circuits on modern, high fidelity receivers properly aligned.
- 2. Audio Response**  
Over-all audio response and "stage-by-stage" analysis measurements made in receivers and P. A. or theater amplifiers.
- 3. Hum Check**  
Objectionable hum quickly traced and eliminated.
- 4. A. F. Amplifier Overload**  
Audio frequency distortion caused by overload or phase shift located and corrected.
- 5. I. F. Amplifier Overload**  
I. F. Overload with resulting A. F. signal distortion found and removed.
- 6. Demodulator Distortion**  
Demodulator Output Waveforms checked and distortion or possible presence of R. F. located.

**Combination Offer!** Model 546 3" Oscilloscope Plus Model 581 Signal Generator, Only \$11.50 down—\$9.48 per month for 12 months on SUPREME S. I. C. terms.

# SUPREME INSTRUMENTS CORP.

GREENWOOD, MISSISSIPPI, U. S. A.

EXPORT DEPT., ASSOCIATED EXPORTERS CO., 145 W. 45th STREET, NEW YORK CITY, CABLE ADDRESS: LOPREH, NEW YORK

## Give Helpful Books for Xmas!

### RADIO · ELECTRICITY Books At Sensationally LOW PRICES

LATEST technical information by nationally known authorities. New popular size books. Crystal-clear explanations. Profusely illustrated. Most outstanding book values in America!

- How to Build Lab. Work Bench. 20c
  - Exper. with 110-V. Elec. Arcs. 25c
  - Motor Transformer Experiments 25c
  - Radio Experimental Manual..... 30c
  - Electrical Experiment Manual..... 35c
  - Starting an Electric Repair Shop 35c
  - Electrical-Radio Dictionary, condensed electrical education. Newest most complete at the price. Explains 676 terms. 217 illus..... 45c
  - Fault Location, Adjustment and Alignment of Radio. Equips you to service your own apparatus or for others..... 65c
  - Characteristics and Trouble Analysis of Radio Apparatus. Every radio-man needs this book..... 75c
  - Radio Servicing Instructions. Circuits, data, operating instructions, etc. Two vol. 222 ill. Both for..... 98c
  - Short Course in Mathematics. Two vol. Amazingly complete. Both for..... \$1.05
  - Short Course in Electricity and Radio. Two vol. 232 ill. Newest, most complete. Both for..... \$1.45
  - Complete Radio-Electrical Library, all 15 books, fine Yuletide gift, postpaid, only..... \$3.98
- ELECTRONIC PUB. CO., Box 323-S, Lincoln, Nebr.



Doing a world-wide job...

## little giant

### compact DRY ELECTROLYTIC CAPACITORS

Original with us in much more than just the name. They fit into the smallest space and yet equal standard sizes in efficiency and reliability. All usual capacities; two ratings, 450 v.w. and 200 v.w. Don't take anything but SOLAR. . . ask your jobber.

Descriptive literature on request.

SOLAR MFG. CORP. 599-601 Broadway New York, N. Y.

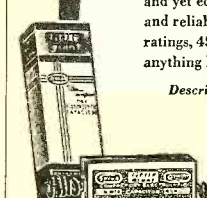



**Another '100 percent'**



**Mr. J. A. CAMPBELL of Scranton, Pa. says:**

... we consider **QUALITY** of parts a major essential ... and are consistently 100% Centralab.

Boy! ... what a boost for Old Man Centralab. But, then ... that's the reward for trying to "make a better mousetrap than our neighbor". No wonder the radiomen have been making a beaten path to our door.

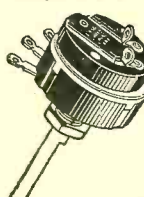

Get the 1937 Volume Control Guide

# Centralab

DIVISION OF GLOBE UNION, INC.  
MILWAUKEE, WIS.

British Centralab, Ltd. Canterbury Rd., Kilburn London N. W. 6, England	French Centralab Co., 118 Avenue Ledru-Rollin, Paris XI, France
---	--

## You, too, Can become a RELIABLE SPEED RADIO OPERATOR

Thousands of operators, just like yourself, have qualified for good paying jobs in radio with CANDLER training. There's always a good place in radio for the CANDLER trained operator. Ask any expert. It's the exclusive SOUND method that developed the CHAMPIONS. And you can learn at home. Surprisingly easy and inexpensive. Don't postpone your future in code any longer. Write today.

### CANDLER SYSTEM CO.

Department RN-1  
Asheville,  
No. Carolina, U.S.A.

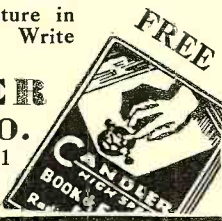

## RADIO ENGINEERING



RCA Institutes offer an intensive course of high standard embracing all phases of Radio. Practical training with modern equipment at New York and Chicago schools. Also specialized courses and Home Study Courses under "No obligation" plan. Catalog Dept. RN-33.

### RCA INSTITUTES, Inc.

A Radio Corporation of America Service  
75 Varick St., New York 1154 Merchandise Mart, Chicago

## The Technical Review

(Continued from page 427)

such a way that they can be made to cancel at a predetermined number of kilocycles off resonance.

*Reactance Amplifiers*, Electronics, October, 1937. Saturable reactors in conjunction with copper oxide rectifiers can be used as amplifiers requiring no tubes. These are suitable for industrial control purposes.

*The Wave-Slot, an Optical Television System*, by F. Okolicsanyi, The Wireless Engineer, October, 1937. A new system of scanning employing quartz crystals and supersonic waves in a liquid—no moving parts.

*Hearing of Speech*, by Bone Conduction, by N. A. Watson, Journal of the Acoustical Society of America, October, 1937. A report of tests performed by the author at the University of California.

### FREE BULLETINS

#### Large 44 Page Catalog

Modell's just announced their latest 1938 catalog No. 409 which lists all the nationally known radio receivers and outlines a new representative

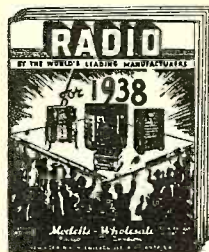

plan. Radio salesmen, servicemen, and any interested reader can obtain a free copy of this catalog by writing to RADIO NEWS, 461 Eighth Avenue, New York City.

### New Tube Chart

Through the courtesy of the Raytheon Production Corp., RADIO NEWS readers can obtain a free copy of the new Raytheon's 11th edition Tube Data Chart. This chart measures 47 inches across by 22 inches wide, and is extremely useful to servicemen and dealers. Address requests to RADIO NEWS, 461 Eighth Avenue, New York City.

### Receiver Folder

The Freed Mfg. Co. announces a new folder which describes and illustrates the new 1938 Freed-Eisemann receiver line. This is free to RADIO NEWS readers for the asking. Simply address requests to RADIO NEWS, 461 Eighth Avenue, New York City.

### Folder on New I.F. Transformers

Copies of the latest Aladdin cata-

log No. 937 on their Polyiron inductors is available without charge to all RADIO NEWS readers. This book lists the complete line of Aladdin i.f. transformers. Write to RADIO NEWS, 461 Eighth Avenue, New York City.

### RADIO NEWS Booklet Offers Repeated

FOR the benefit of our readers, we are repeating a list of valuable, FREE technical booklets and manufacturers' catalog offers, which were described in detail in the July, August, September, October, November, December 1937, issues. The majority of these booklets are still available to all readers. Simply ask for them by their code designations and send your request to RADIO NEWS, 461 Eighth Avenue, New York, N. Y. The literature marked with an asterisk is available only to bona fide servicemen, dealers and engineers. In applying for these folders it is necessary to send in your request on your card or letterhead. If you are an amateur give call letters. The list follows:

Jy2—Instrument Catalog. Triplet Electrical Instrument Co.

At1—Broadside on Super-Pro. Hammarlund Mfg. Co.

At2—Catalog on Transmitting Equipment. Wholesale Radio Service Co., Inc.

At4—Tube Folder. Weston Electrical Instrument Corp.\*

At5—P. A. Catalog. Webster Co.

S2—Transformer Catalog. Kenyon Transformer Co.

O1—Vibration Study with Neobeam Oscilloscope. The Sundt Engineering Co.\*

O2—Sound Equipment Catalog. The Radolek Co.

O3—Instructive data for eliminating interference. The Sprague Products Co.\*

O4—Catalog on "Nokoil" Speakers. Wright-DeCoster, Inc.

O5—Circular describing gas-engine a.c. electric plants. Kato Engineering Co.

O6—Replacement Condenser Catalog. Solar Mfg. Co.

O7—Guide Book on Peri-Dynamic Speakers. Jensen Radio Mfg. Co.

N1—Parts Catalog. Wholesale Radio Service Co.

N3—Catalog on Radio Accessories, Cabinets, etc. Bud Radio, Inc.\*

N4—Allied Radio Corp. Parts Catalog.

D1—R.M.A. Color Code Chart. Free. Cornell-Dubilier Corp.

D2—Condenser and Resistor Catalog. Aerovox Corp.

D3—Technical Pamphlets on Intercommunication Systems. Wright-DeCoster, Inc.

D4—Transmitter Manual. Standard Transformer Corp.\*

D5—"Skyrider" Receiver Booklet. Hallicrafters, Inc.

D6—The Muter Ballast Tube Catalog.\*

D7—Centralab's Volume Control and Accessory Catalog.



## QRD? QRD?

(Continued from page 429)

London and its immediate vicinity. The system employed is fundamentally based on the RCA Television System first developed here. . . . Some 15 British radio manufacturers have sets offered around \$200 to \$500 each. At the Olympia Radio Show all the manufacturers exhibited their latest sets and the BBC arranged special programs for them. From a technical viewpoint the results were highly satisfactory. But while hundreds of thousands purchased ordinary broadcast receivers, less than 100 television sets were bought. There are less than 2000 television sets in England. What RCA is waiting for is the erection of sufficient stations all over the country for commercial purposes and to bring good programs over a national set-up. And as soon as this is all ironed out, television will be practically on its way to the public's front doorstep."

Across the Ed's elbow-rest come "bon mots" from Skagway, Alaska, amongst others. It seems that even in that far away tip, radiops want to be handling a key in some airways here in the States. And I thought the grass was greener there! Well, sir, most of the large airlines are pretty well lined up but if any of the brethren know of some of the spots which could place likely material from up in the silent North, just shoot it in and we'll pass it along. PanAm, AmAir, TWA, etc. are pretty well full-up. And whilst on the Northland subject, we note it's time for Santa Claus and the Xmas cheer and "Peace on Earth and all the Seas, Good Will to men." And may you all have a pleasant Xmas, a Happy New Year and all the fixings. So with a cheerio, ge . . . 73 . . . GY.

## D. C. Voltmeter

(Continued from page 403)

- R6A—IRC wire-wound resistor, type DHA, 12,000 ohms., 25 watts, set at 9800 ohms
- R6B—IRC wire-wound resistor, type DG, 30,000 ohms., 20 watts
- R7A—IRC wire-wound resistor, type DHA, 20,000 ohms., 25 watts, set at 15,000 ohms
- R7B—IRC wire-wound resistor, type DG, 30,000 ohms., 20 watts
- R7C—IRC wire-wound resistor, type DG, 40,000 ohms., 20 watts
- R8—IRC carbon resistors, type BT½, 100 ohms, ½ watt, combined to total 195 ohms
- R9—IRC carbon resistors, type BT½, ½ watt, combined to total 890 ohms
- R10—IRC carbon resistors, type BT1, 1

- watt, combined to total 5800 ohms
- R11—IRC carbon resistors, type BT½, ½ watt, combined to total 12,500 ohms
- R13—Yaxley potentiometer, type 17, 2000 ohms, wire-wound, linear
- R14—IRC wire-wound resistor, type ABA, 25 ohms, 10 watts, set at 23.5 ohms
- R15—IRC carbon resistor, type BT1, 20 ohms, 1 watt
- S1, S2—H&H toggle switch, d.p.d.t.
- S3—H&H toggle switch, s.p.d.t.
- S4—H&H toggle switch, d.p.s.t.
- S5—Yaxley range switch, 1315 L., 2 circuit, 5 positions, non-shorting
- 1—Yaxley pilot light bracket, type 310R
- 1—pilot lamp, 2 volt, 60 ma
- 2—Yaxley ¼-inch black bar knobs No. 366
- 1—Yaxley Hex head tip jack No. 420, red
- 1—Yaxley Hex head tip jack No. 421, black
- 1—Triplett meter, model 421, 1 ma., square type
- 1—RCA type 30 tube
- 1—ICA engraved panel, special, 3/16-inch bakelite to fit cabinet
- 2—Eveready A cells, No. 711, 1.5 volts each
- 3—Eveready B batteries, No. 762, 45 volts each
- 1—Parmetal steel cabinet, type P.C. 1276, 12x7¼x6½ inches
- 1—Eby moulded 4-prong socket, type 12 Bakelite for two small sub-panels

## "Progressive" X'mitter

(Continued from page 411)

- 1 Parmetal type SB-78 set of mounting brackets
- 1 Parmetal type C-4526 chassis, cadmium plated, 10 by 17 by 3
- 1 Parmetal type CP-4526 bottom plate for chassis
- 1 RCA 6N7 tube
- 2 RCA 6L6 tubes (two more required later for high-power output)
- 1 Yaxley type 310G pilot light
- 1 octal wafer socket
- 1 wafer socket, 4-prong

## Starts New Company

Chicago, Ill.—David E. Johnson, formerly president of the Dayton Radio Products Co. and recently sales manager of the Bendix-DayRad division of Bendix Products Corp, of South Bend, Indiana, will shortly start manufacture of a complete line of radio and electrical testing equipment at Dayton, Ohio. By arrangement with Bendix Products Corp., Mr. Johnson will provide renewal parts and authorized service on Dayton or Bendix-DayRad equipment now in use.

## Studio on Wheels

Baltimore, Md.—Station WFBR now has a new mobile studio which is built on a trailer 25 feet long, 6 feet wide and 10 feet high. This mobile studio with its control room has all the equipment of the regular studios. It is to be moved by means of a truck which will carry a 500 watt transmitter and turntables. It is planned to visit every town in Maryland with this equipment, to transmit and record programs by local talent and to retransmit the recorded features later from the main station so the participants can hear.

Here are the prize winners in Wholesale Radio Service Co.'s great contest:

- ★ FIRST PRIZE (\$250.00) W. E. McLAIN  
MARSHALL, MICHIGAN
  - ★ SECOND PRIZE (\$150.00) JACK E. BANNON  
OIL CITY, PENNSYLVANIA
  - ★ THIRD PRIZE (\$100.00) CLINTON L. KINZEY  
INDEPENDENCE, MISSOURI
- and 50 others who won \$10.00 each

What a contest! From all over the world the letters poured in. To each enthusiastic entrant went a copy of the big new WHOLESALE Catalog with its 50,000 listed items at rock-bottom prices. 180 pages indexed for easy reference. A "goldmine" of radio values right at your elbow. Every one of you who got this catalog is a winner—for you'll save dollar after dollar by making your purchases from its pages. Here's just a sample of what the catalog includes:



### PUBLIC ADDRESS EQUIPMENT

Page upon page of famous Lafayette P.A. systems in all sizes for every conceivable demand or requirement. There's money in this new field and the FREE catalog shows you how to make it! Whether you rent, sell or install, you'll want this book.

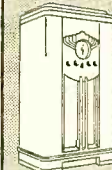

### LAFAYETTE RECEIVERS

35 pages devoted to Lafayette's new line for 1938—70 brilliant models. Priced so low you can have that "extra set" at last. Study the receivers illustrated in the FREE catalog. Discover what real radio value is.



### TEST AND HAM EQUIPMENT

The greatest collection of up-to-morrow test instruments you've ever seen. To delight the "ham"—every nationally advertised make of amateur equipment. All in the FREE Wholesale catalog at prices that cannot be beaten.

**MAIL THIS COUPON NOW**

**WHOLESALE RADIO SERVICE CO. INC.**  
NEW YORK, N.Y. • CHICAGO, ILL. • ATLANTA, GA.  
100 SIXTH AVENUE • 901 W. JACKSON BLVD. • 430 W. PEACHTREE ST., N.W.  
BOSTON, MASS. • BRONX, N.Y. • NEWARK, N.J. • JAMAICA, L.I.

WHOLESALE RADIO SERVICE CO., INC.  
100 SIXTH AVENUE, NEW YORK, N. Y.

Rush FREE 1938 Catalog No. 69-2A8   
Rush FREE XMAS Catalog No. 70-2A8

NAME \_\_\_\_\_  
ADDRESS \_\_\_\_\_  
CITY \_\_\_\_\_ STATE \_\_\_\_\_



**ALL OUT OF 1 BOOK!**

**Ghirardi's COMPLETE \$4 RADIO PHYSICS COURSE**

Here's your whole radio education—ready and waiting for you between the covers of this one huge 972-page book. There's so much information in it that every single one of its 36 chapters is equivalent to a whole book of ordinary size. Comprehensive!—say fellows, this one book will teach you everything—ELECTRICITY, RADIO, SOUND—even TELEVISION! Once you see it you'll agree that Ghirardi is a genius for getting all there is to know into one big, easy-to-use volume. You'll find every single one of its 972 large pages crammed full of just the kind of information you need—all carefully simplified so everything is really easy for you to understand. Plain, understandable language, freedom from unnecessary mathematics, and more than 500 clear illustrations make it the world's best, easiest and most interesting book to learn radio from. That's why it is used in the courses of more radio schools than any other radio book in the world. Both instructors and students say it's the best there is at any price! You need it too. And you get it at the amazingly low price of only \$4. Don't delay—start your radio training NOW! Mail the Coupon below—AT ONCE! Remember—every penny of your money back if not fully satisfied. Sent Postpaid Anywhere!

**WHAT YOU WILL LEARN FROM THIS BOOK!**

Sound, Speech and Music . . . Electrons . . . Electric Current . . . Electric Units and Circuits . . . Resistance . . . Ohm's Law . . . Batteries . . . Magnetism . . . Electromagnetism . . . Transformers . . . Inductance . . . Condensers . . . Alternating Current Circuits . . . Filters . . . Electrical Measuring Instruments . . . Radio Waves and Radiations . . . Broadcast Stations . . . Receiving Equipment . . . Vacuum Tubes . . . Radio and Audio Frequency Amplification . . . Superheterodynes . . . Loud Speakers . . . Battery Operated Receivers . . . Power Supply Units . . . Electric Receivers . . . Automobile and Aircraft Receivers . . . Photograph Clunks . . . P.A. Systems . . . Short-Wave Receivers . . . Photoelectric Cells . . . Television . . . Antennas and Grounds . . . Testing and Servicing Receivers . . . Sound Motion Pictures . . . Appendixes . . . 856 Review Questions for Self-Study . . . AND LOTS MORE!

**LEARN RADIO IN YOUR EASY CHAIR!**

Paste this Coupon on a Postcard—MAIL TODAY!

**To: RADIO & TECHNICAL PUBLISHING CO.**  
45 ASTOR PLACE • NEW YORK

Encl. and \$4. Send my RADIO PHYSICS COURSE at once, postpaid. (Foreign \$4.50)  
 Send me a free circular describing this book.

Name.....  
Address.....  
Dept. RN-1E

**MONEY-BACK GUARANTEE!**

**1938 RADIO PARTS CATALOG**

Showing the Latest **RADIO EQUIPMENT** FOR THE DEALER THE SERVICEMAN AND THE AMATEUR

Our New Catalog just off the Press Write for your free copy—Now!

**CAMERADIO**

563 LIBERTY AVE. PITTSBURGH, PA. 30 TWELFTH ST. WHEELING, W. VA.  
Established 1919

**RADIO COURSES**

RADIO OPERATING: Prepare for Gov't License Exam. • RADIO SERVICING: Including Short Wave • AMATEUR CODE • ELECTRONICS • TELEVISION •

Day and Evening Classes—Booklet Upon Request

**NEW YORK Y.M.C.A. SCHOOLS**  
7 W. 63rd Street, New York City



**WJBO'S DX PROGRAMS A REAL TREAT**

Here's the control room of the new WJBO with Wilbur T. Golson, chief engineer. Listen for the Radio News "Extra Special" on Sunday morning, December 5, from 2 to 4 a. m., E.S.T.—and also the regular Radio News broadcasts at the same hours on the first and fourth Sundays of each month. The frequency is 1120 kc. and the power 500 watts.

**THE DX CORNER**

(For Broadcast Waves)

S. GORDON TAYLOR

**DX CALENDAR**

Below are given lists of special DX broadcasts. The initials following an item indicate the organization to which the program is dedicated and where a Radio News special has been arranged for by an Observer, his name is given in the schedule.

Don't fail to tune in the Radio News specials on this list and as many others as possible—and above all, don't fail to report to each station tuned in, giving them as much information as you can concerning their signal strength, fading, quality, etc. Where verifications are desired it is always desirable to enclose return postage.

Hours shown are Eastern Standard Time and are all a.m. unless otherwise indicated.

Day	Hour	Kc.	Call	State	Kw.	Club
<b>December</b>						
1	2-2:30	1310	KWOS	Mo.	.1	NNRC
1	4-4:30	1370	WPAY	Ohio	.1	NNRC
3	3-4	1390	KRLC	Idaho	.25	NNRC
4	1-3	1160	XED	Mexico	2.5	
4	2:30-2:45	1280	KLS	Calif.	.25	URDXC
4	2:45-4	780	CHWK	Canada	.1	NNRC
4	3:30-4	1310	WEXL	Mich.	.05	NNRC
5	1-2	580	WILL	Ill.	1.	UDXC
6	2-4	1120	WJBO	La.	.5	R. News Golson
5	3-4	1180	KOB	N. Mex.	10.	IDA
5	4-5	580	WILL	Ill.	1.	UDXC
6	4:30-6	1310	WRAW	Pa.	.1	NNRC
8	2:40-3	1240	WKAQ	P. R.	1.	R. News Sahlbach
9	4-4:30	1370	WPRA	P. R.	.1	NNRC
10	1:30-2	1060	WJAG	Neb.	1.	NNRC
11	1-3	1160	XED	Mexico	2.5	
11	2:30-2:45	1280	KLS	Calif.	.25	URDXC
11	3-4	1390	KRLC	Idaho	.25	NNRC
11	5:40-5	1310	KXRO	Wash.	.1	R. News Sahlbach
12	2-5	900	WFMD	Md.	.5	NNRC
12	2:45-4:30	1010	CKWX	Canada	.1	IDA
18	1-3	1160	XED	Mexico	2.5	
18	2:30-2:45	1280	KLS	Calif.	.25	URDXC
19	5-6	1420	KIUN	Texas	.1	UDXC
23	3-4	1130	WJJD	Ill.	20.	IDA
25	1-3	1160	XED	Mexico	2.5	
25	2:30-2:45	1280	KLS	Calif.	.25	URDXC
25	3-4	1390	KRLC	Idaho	.25	NNRC
25	3-5	1220	KWSO	Wash.	1.	
26	2-4	1120	WJBO	La.	.5	R. News Golson
30	1-2	1070	WTAM	Ohio	50.	IDA
31	5:30-6	1050	WEAU	Wis.	1.	NNRC
7	2-4	1120	WJBO	La.	.5	R. News, Golson
6	2-2:30	1310	KWOS	Mo.	.1	R. News, Sahlbach
8	4:10-4:30	1500	WKBZ	Mich.	.1	R. News, Sahlbach
8	5:10-5:30	1200	KBTM	Ark.	.1	R. News, Sahlbach
8	5:30-5:50	1200	KFXD	Idaho	.1	R. News, Sahlbach
8	5:40-6	1410	KFJM	N. Dak.	5	R. News, Sahlbach
10	4:20-4:40	1370	KLUF	Texas	.1	R. News, Sahlbach
10	4:50-5:10	1420	KEUB	Utah	.1	R. News, Sahlbach
10	5:50-6:10	1210	KGLO	Iowa	.1	R. News, Sahlbach
11	3:10-3:30	1260	KPAC	Texas	.5	R. News, Sahlbach
11	4:10-4:30	1370	KAST	Oregon	.1	UDXC
11	5-5:20	1370	KRMC	N. Dak.	.1	R. News, Sahlbach
11	5:50-6:10	1210	KLAH	N. Mex.	.1	R. News, Sahlbach
12	3:10-3:30	1210	WPAX	Ga.	.1	R. News, Sahlbach
12	4:40-5	1500	KPLT	Texas	.25	R. News, Sahlbach
12	5-5:20	1200	KFJB	Iowa	.1	R. News, Sahlbach
14	4-4:20	1210	KIUL	Kans.	.1	R. News, Sahlbach
14	5:30-5:50	1310	WLBC	Ind.	.1	R. News, Sahlbach
16	3-4	810	WCCO	Minn.	50.	IDA
16	5-6	1370	KOBH	S. Dak.	.1	UDXC
23	2-4	1120	WJBO	La.	.5	R. News, Golson
24	3-4	1150	WHAM	N. Y.	50.	IDA
30	3-4	780	CHWK	Canada	.1	IDA
<b>Periodic</b>						
<b>Mondays—</b>						
9:15-9:30 p.m., 690 kc., CJCJ, Calgary, Alta., Canada, 1 kw. (R. News) (tips)						
<b>Wednesdays—</b>						
12:30 a.m., 1390 kc., KOY, Phoenix, Ariz., 1 kw. (tips). 1:45-2 p.m., 780 kc., WTAR, Norfolk, Va., 1 kw. (URDXC) (tips).						
<b>Saturdays—</b>						
1-1:10 a.m., 1390 kc., KLRA, Little Rock, Ark., 1 kw.						
<b>Sundays—</b>						
12:45-1 a.m., 1280 kc., KLS, Oakland, Calif., .25 kw (URDXC) (tips). 2:45-3 a.m., 1010 kc., CKWX, Vancouver, B.C., Canada, 1 kw. 3-3:30 a.m., 1410 kc., CKMO, Vancouver, B. C. Canada, 1 kw. 3:30-3:45 a.m., 570 kc., KMTR, Los Angeles, Calif., 1 kw. (tips).						
<b>Monthly—</b>						
1st day of month, 3-4 a.m., 1290 kc., WTOG, Savannah, Ga., 1 kw. 1st Sunday of month, 4-4:30 a.m., 1340 kc., KGDY, Huron, S. Dak., .25 kw. 2nd Tuesday of month, 5-5:30 a.m., 1370 kc., KRMC, Jamestown, N. Dak., 1 kw.						



**"Radio News" Broadcast**

ON Friday, December 17, RADIO NEWS will go on the air with a special International program dedicated and directed to Official Listening Post Observers throughout the world. Among the features will be a talk by S. Gordon Taylor on the utility and DX possibilities of the new ranges below 10 meters. In order to insure world-wide coverage the broadcast will be repeated three times in all. The initial transmission will be from 4:00 to 4:30 p. m., E.S.T., and will take place over both W2XAF (9.53 megacycles) using its non-directional radiator, and W2XAD (15.33 megacycle) with its European beam. At 11:30-midnight the broadcast will be repeated over W2XAF, using its South American beam. Again at 7:00-7:30 the next morning (Saturday, December 18) the broadcast will go out over W2XAF. This time to listeners in Australia and other far-distant countries.

**DX Corner**

**"Regular" DX**

IT is the purpose of the DX Calendar to list special DX broadcasts, tips broadcasts, etc. There are quite a number of stations whose regular broadcast time extends into the early morning hours and which, therefore, provide an opportunity for DX work in the morning. A group of such stations as suggested by Observer Parfitt is listed herewith. The hours are all a.m.

E.S.T.	Kc.	Call	Location
5:00	840	XERA	Villa Acuna, Mex.
	1000	KFVD	Los Angeles, Cal.
	1040	KWJJ	Portland, Ore.
	1070	KJBS	San Francisco, Cal.
	1370	WABY	Albany, N. Y.
5:30	1410	WAAB	Boston, Mass.
	1500	WJBK	Detroit, Mich.
	750	WJR	Detroit, Mich.
	1200	WIBX	Utica, N. Y.
	700	WLW	Cincinnati, Ohio
5:45	580	WIBW	Topeka, Kans.
5:55	570	WSYR	Syracuse, N. Y.
	920	WWJ	Detroit, Mich.
	930	KMA	Shenandoah, Iowa
	1070	WTAM	Cleveland, Ohio
	1160	WWVA	Wheeling, W. Va.

Mr. Parfitt has also suggested another list of "regulars" of special interest to listeners who do their DX'ing on Saturday night. These stations are on at the time specified on Saturday nights (or Sunday morning). All times are Eastern Standard.

Kc.	Call	Hours
570	WIND	to 5:00 a.m.
620	WTMJ	Irreg. 3 a.m.
640	KFI	to 3:00 a.m.
670	XELO	New freq. till 2 a.m.
710	KIRO	All night
840	XERA	All night
890	KFPY	to 4:00 a.m.
910	XENT	All night
940	XEFO	to 2:00 a.m.
960	XEAW	to 2:00 a.m.
1000	KFVD	All night
1030	CKLV	to 4:00 a.m.
1040	KWJJ	All night
1050	KNX	All night
1100	KGDM	After 3 a.m.
1100	KWKH	to 3:00 a.m.
1110	KQW	to 4:00 a.m.
1160	WWVA	to 2:30 a.m.
1200	WIL	to 5:00 a.m.
1250	WNEW	All night
1280	KLS	All night
1290	KTRH	to 3:00 a.m.
1300	WEVD	to 4:00 a.m.
1370	KCMO	to 5:00 a.m.

(Turn to page 447)

*Super-Sensitivity*

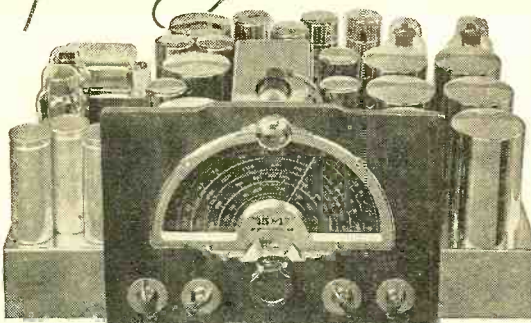

29

**IMPORTANT FEATURES**

★ Here, in a new and straight forward circuit, is the super-sensitivity that make McMurdo Silver MASTERPIECE V's the exclusive choice of VE1IN, the Bowdoin-Kent Island Expedition now in the Arctic. This same super-sensitivity comes to you in the new "15-17". With it you can listen with pleasure to broadcast and short wave stations from near and far, for the "15-17" measures better than 3:1 signal to noise ratio at one-half microvolt absolute sensitivity.

This is made possible by its exclusive stabilized regenerative tuned r. f. stage, which equals two ordinary tuned r. f. stages, and its exclusive new TRI-BAND i. f. amplifier. Imagine such super-sensitivity coupled with your instant choice of razor sharp 3 kc., general purpose 8 kc., and full throated 16 kc. high fidelity selectivity, double action a. v. c. eliminating both fading and overload, dual control of that truly MASTERPIECE tone which radio editors praise and musicians choose, and you have the "15-17".

Band spread is inches, not just a few degrees, on all short wave bands, wave length range is 530 to 32,000 kc. (yes, the "15-17" is "hot" on 10 meters, as it is all over all bands). Finish is polished chromium—construction is MASTERPIECE throughout—but if you want the story of this really superb all wave, high fidelity receiver, you'd better mail the coupon.

Besides new sensitivity, there are 29 additional reasons why you want a "15-17" receiver custom-built for you. It has the performance and features you would expect only at triple its extremely low cost. 15 tubes performing 17 functions before a Jensen-Silver 15 inch Giant speaker, housed in a hand customed, solid and heavy Bifarian (bass-reflex and peri-dynamic) console, acoustically perfect. "15-17" is radio's greatest value today, bringing MASTERPIECE quality to every home.

When the best costs less and you can buy it for only \$28.00 down — it pays to investigate. Mail the coupon below for free particulars and our Introductory Offer.

*Individual Custom Built Radio*



McMURDO SILVER CORP.,  
2900-A South Michigan Blvd.  
Chicago, Illinois

Send me full "15-17" details.

Name \_\_\_\_\_

Address \_\_\_\_\_

**TELEVISION FANS!**

Make sure you get every installment of "Practical Lessons in Television" by subscribing for RADIO NEWS today!



**LOOK!  
YOU DX HOUNDS  
FREE**

**NEW RACO CATALOG OF  
LONG DISTANCE  
RECEIVERS**

Kits, receivers, converters, valuable antenna information—everything you'd expect to find in a complete short-wave catalog—at prices astoundingly low. Write today for RACO'S LATEST SHORT-WAVE CATALOG—illustrating, and technically describing RACO'S complete line of long distance receivers. Address: Dept. RN-138

**RADIO CONSTRUCTORS LABORATORIES**  
136 LIBERTY ST. NEW YORK, N. Y.

**HANDEE**  
*Tool of 1001 Uses*

**A NIFTY GIFT  
For Boys from 7 to 70**  
A whole shop full of tools in one. Grinds, polishes, routs, drills, cuts, carves, sands saws, sharpens, engraves. Uses 200 accessories. Plugs in any socket AC or DC 110V, 13,000 r. p. m.



**Get A Demonstration**  
at Hardware, Dept. Stores, Tool Dealers or order on 10 Day Money-Back Trial, \$10.75 and up postpaid, 3 Accessories Free. De Luxe Model \$18.50, with 6 Accessories. Catalog Free.

**New CRAFTSMAN Project Book**  
"Pleasure and Profit with a Handee." Easy working plans for making many interesting and unusual projects 25c, stamps or coin.

**CHICAGO WHEEL & MFG. CO., 1101 W. Monroe St. Dept. AB, Chicago**



**WORLD'S  
Finest  
RADIO**

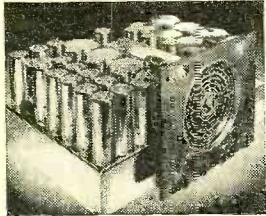

**★  
SCOTT Philharmonic**



"If you do not know the kind of radio reception actually obtained today behind locked doors of Research Laboratories, you will be amazed at the performance of my Custom Built instruments in your home."  
"Each precision built receiver is **HAND MADE** in Labora-

tories (not a factory) for performance impossible with mass-produced radios. Scott receivers have been known the world over for 15 years as the 'Rolls Royce of Radio.' I have built them for 982 world famous men and thousands of others who want the best. Now, ANYONE can own a Custom Built Scott. My newest 16-tube model, only \$59.50 down, \$12 a month, F. O. B. Chicago."

**A FEW OF 93 AMAZING FEATURES**

- 3 to 10 times as powerful as many production-line radios of same price.
- My receivers hold 6 official World's Records on Foreign reception.
- 50% Higher Fidelity than average high-priced radio—finer tone than costliest motion-picture sound system.
- Improves poorly transmitted broadcasts.
- Four Static-Reducing Systems (both electrical and atmospheric).
- Up to 300% more handling capacity than ordinary radios.
- Can instantly be adjusted to difficult receiving locations.
- NOT SOLD THROUGH STORES—30-day home trial with Money-Back Guarantee.

**GET ALL THE FACTS—MAIL COUPON NOW!**

E. H. SCOTT, Pres. E. H. Scott Radio Labs.  
4440 Ravenswood, Dept. 5A8, Chicago, Illinois  
Send all the facts, order blank, and Special Offer. No obligation.

Name \_\_\_\_\_  
Address \_\_\_\_\_  
City and State \_\_\_\_\_

SCOTT SALONS in NEW YORK, CHICAGO, LOS ANGELES

**For HOME Radios For AUTO Radios**

**HOME RADIO POCKET TROUBLE SHOOTER** **AUTO RADIO POCKET TROUBLE SHOOTER**

**Service!**

**IS 10 TIMES FASTER**

**WHEN YOU USE THE "Twin-Gadgets"**  
SPEED UP YOUR SERVICE WORK with these new fast-working Gadgets. How do they work? Easy as pie—you take up your Gadget, pick out the card marked for the Trouble Symptom you find in the sick receiver; flip the card around—and there you'll see all the tests to make and all the remedies, set down next to all the possible trouble sources. It works quicker than it can be described. A half second's time and you have all the dope you want right before your eyes. The most ingenious servicing aid ever invented. **OVER 400 DIFFERENT SET TROUBLES** are spotted on each of the Gadgets. You need both of them to cover all jobs—one for HOME RADIO sets and one for AUTO RADIO sets. And all they cost is \$1 A PAIR (\$1.20 foreign)—only \$1 to save you hours and hours of headaches, worry and wasted time. Don't delay—get your Gadgets today and let them coin money for you. Write your name and address on this ad and send it in with a dollar today! Sent postpaid anywhere on 5-day trial!

**GHIRARDI'S POCKET TROUBLE SHOOTERS**  
Radio & Technical 45 Astor Place,  
Publ. Co., Dept. RN-18 New York, N. Y.

**MAIL \$1 NOW! MONEY-BACK GUARANTEE!**

**110 VOLTS A. C.**  
Anytime! Anywhere! With **KATOLIGHT PLANTS**  
350 watt 110 v. 60 cycle A.C. \$59.60  
300 watt 22 volt D.C. plant 78.40  
15 amp. 12 volt charger... \$9.95  
25 amp. 6 volt charger... \$9.95  
A.C. & D.C. Generators... Rotary Converters... 32 Volt 800 Watt Wind Plant... \$141.00

Write for...  
**KATO ENGINEERING CO.,**  
Mankato, Minnesota, U. S. A.

**LES Correspondence Courses In RADIO and ELECTRICAL ENGINEERING**

**ELECTRICAL ENGINEERING** Get good electrical field. Prepare yourself, at Low Cost, for secure future. Modern course. So simplified anyone can understand quickly.

**RADIO ENGINEERING** Extra fine course in radio, public address, photoelectric work. Train you to be super-service man, real vacuum tube technician. Experimental kits furnished. Diploma on completion. Tuition ONLY **FREE!** \$25, either course. Deferred payment plan available.

Send name quick for free copies of school catalogs, student magazines, complete details. **SEND NOW!**  
**LINCOLN ENGINEERING SCHOOL, Box 931-59, Lincoln, Nebr.**

**AT YOUR DEALER'S**

NEW RADIO PRODUCTS

(Continued from page 406)

recently introduced by the Radio-technic Laboratory features visual and aural indications of the condition of the tube under test, in addition to the usual meter test. Tube noises resulting from loose elements and intermitting shorts are made

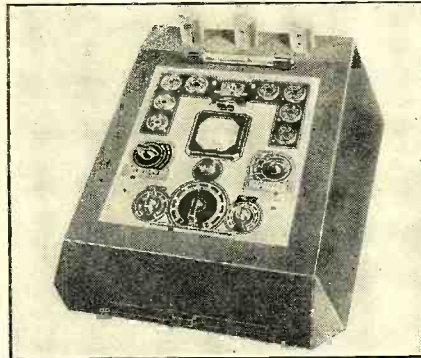
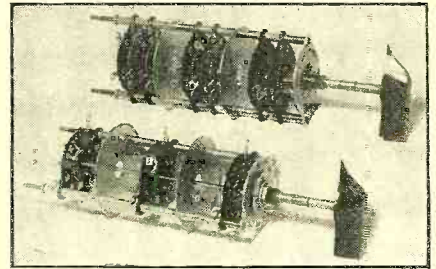

ceivers. For this army of fans who like to "roll their own", P. R. Mallory and Company introduces two new Yaxley band change switches, type 153L and 156L, illustrated in the accompanying photograph.

The three section switch is designed for 3-band operation and accommodates two circuits per section or a total of six circuits. The six section switch is designed for 5-band service, one circuit per section or a total of six circuits. The contacts on this switch are double-spaced to provide easy wiring and to insure the lowest capacity between leads.

These new switches offer several constructional features indicating that careful attention was given to their design and application. They are built for extremely low contact resistance and minimum capacity between circuits; note the large shield between each section. Both switches are made with shorting shoes which short-circuit or ground all unused coils. The size of the switch has been figured out so that the overall length approximates that of a three-gang tuning condenser and the space between the decks coincides with the spacing of the sections in the typical gang condenser, thereby permitting short leads.

**Armchair Radio**

An attractive adaptation of the new armchair radio vogue is offered by the Allied Knight 7-tube all-wave receiver. It features an 8-inch dynamic speaker, automatic tuning of any ten favorite stations, a tuning electric eye, and others. The cabinet is pleasingly

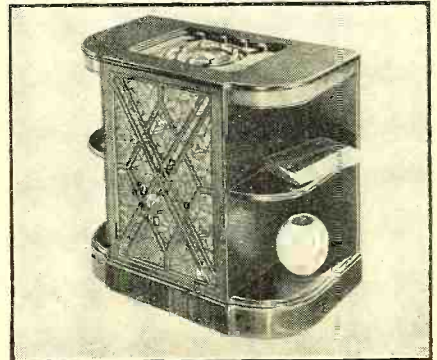

plainly audible to the customer by means of a small earphone attached to the tester. Pressing the test button causes a light to appear red, amber or green, correspondingly for a bad, weak, or good tube.

**New Instrument for Modern Servicing**

The Million Radio & Television Labs. announce a new a.c.-d.c. all-wave oscillator covering a frequency range from 100 to 25,000 kilocycles in 5 bands. The large dial is direct reading on all ranges providing over

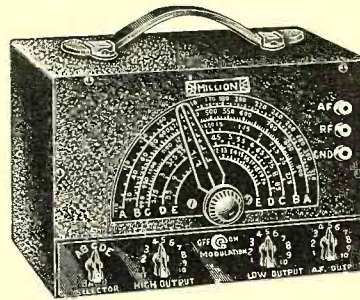

40 inches of dial scale. A separate tube is utilized to furnish the 400 cycle audio modulation note, with its own attenuator for amplifier checks. The radio frequency attenuator system uses a buffer amplifier tube to permit high output for starting alignment. It is designed for simple, rapid, and convenient operation.

**Universal Wave-Band Switches**

Heretofore, the experimenter and home constructor found it extremely difficult to obtain suitable switches to meet the universal coil switching requirements in home built all-wave re-



styled of matched walnut woods. Tuning controls are recessed in the top and convenient shelves at both sides accommodate decorative pieces and books.

**Heavy Duty Test Leads**

The Bud "Master" test leads are unusually well constructed, designed to stand up under hard usage. They are equipped with needlepoint tips of hardened steel to break through corrosion and insulation; and an im-

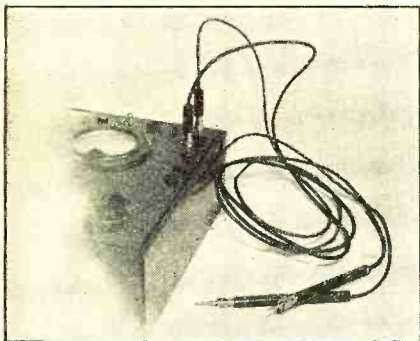

portant feature of these leads is the fact that worn or broken wires are easily replaced without soldering.

**Announces New Headset**

This is the new Trimm lightweight commercial headset especially made for aircraft, commercial, and amateur



operators. The high points of the headphones are rugged construction, high sensitivity, and response characteristics, substantially uniform throughout the usable voice range. The phones are designed to handle up to 1 watt without rattling. The absolute sensitivity is rated better than 0.1 microvolt across the terminals for a barely audible signal.

**Noise Free Control**

The International Resistance Company's latest line of volume controls with the "Silent Spiral Connector" is this company's answer to the demand for better, quieter controls for those critical special replacement jobs that cannot be handled with standard control types. By means of a

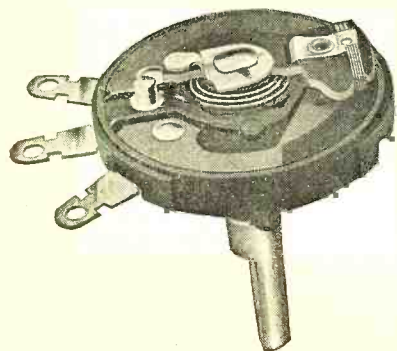

spiral spring wire, positive and continuous electrical connection is obtained between the center terminal and the volume adjustment arm. This new control also has a "Knee Action" feature permitting a 5-finger element contact.

**Covers Broadcast and Short-Wave Bands**

This is the new Freed-Eisemann

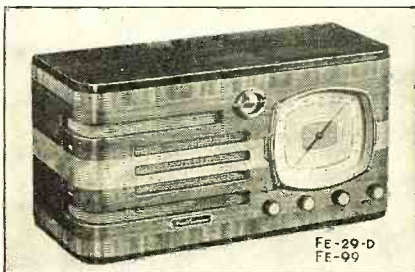

model 29D dual-band receiver. Foreign readers will be especially interested in this set as it is designed to operate from either alternating or direct current and it covers the short-wave ranges from 5.5 to 18 megacycles; in addition to the standard broadcast band, 550 to 1600 kilocycles. It is an 11-tube set and utilizes four of the new K34B type tubes.

**New Table Set Presents Smart Appearance**

This is the new Allied Knight a.c.-d.c. radio receiver inclosed in a new smart looking plastic colored cabinet. These bakelite enclosures are available in four colors; red, black, ivory, and walnut. Its wavelength range is from 75 to 550 meters, and the tube equipment comprises one 6D6, one

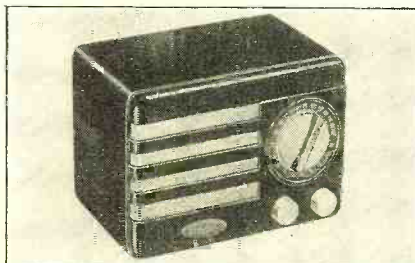

6C6, one 25L6, one 25Z5, and one L49C tube.

**New Antenna for Greater Sensitivity**

The Arrow model auto-top antenna produced by the Wedge Mfg. Company, mounting on rubber vacuum cups, has been (Turn to page 448)



**PIONEERS  
IN THE  
DEVELOPMENT  
OF  
AUTO-RADIO  
TUBES**



RAYTHEON pioneered the first outstanding tube developments that made home-like reception in auto-radios possible! Since then, Raytheon auto set tubes have been noted for their maximum life under adverse conditions—for their noiseless reception under extreme sensitivity! Raytheons, too, are especially designed and constructed for maximum life over the wide range of voltages in an automobile battery—to work efficiently in close proximity to each other—to withstand the jarring and pounding received on the roughest of roads.

It is almost impossible to find a modern auto-radio not using the latest Raytheon development—the OZ4 rectifier! This fact is a universal tribute to Raytheon engineering. These are reasons why more auto-radio manufacturers use Raytheon than any other tube—and why almost all servicemen use them as replacements.

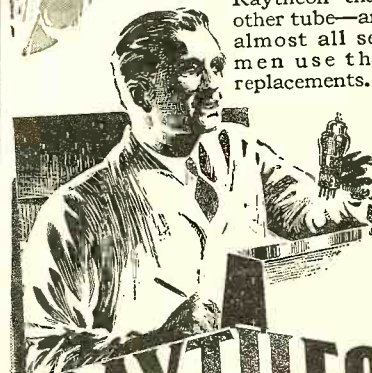

**RAYTHEON**

445 Lake Shore Drive, Chicago, Ill.  
55 Chapel Street, Newton, Mass.  
420 Lexington Ave., New York, N. Y.  
555 Howard Street, San Francisco, Cal.  
415 Peachtree Street, N. E., Atlanta, Ga.

**FOR BETTER RECEPTION**



**LET ME TRAIN YOU *at home***  
**FOR A GOOD RADIO JOB**  
**Get in Line for Big Money!**



Radio is growing fast. Modern receivers require thoroughly trained experts for service and maintenance. You can become such an expert... *right at home*... through R.T.A. methods and begin earning money almost from the start of your course. In a very short time you will

**Be the ONE Man in 1,000**  
 who understands everything there is to know in order to give quick "sure-fire" service to all kinds of receivers. You can be the one man who can take the service business away from the old-time radio "tinker."

**No Experience Needed**  
 Even though you know nothing about Radio now, you can quickly qualify the R.T.A. way to step right into a well paying position or start your own profitable business. Use your spare time and

**LEARN AT HOME**  
 Most R.T.A. members start making money right from the beginning. The special servicing equipment which is supplied without extra cost makes this possible. Don't wait—get started now. Write today for our Interesting Radio Book FREE.

**INCLUDED WITH OUR TRAINING**



This efficient time-saving, trouble-finding Circuit Analyzer and Resistance Tester helps you to make money without delay.

**Don't Put It Off—Send Coupon Now**  
 RADIO TRAINING ASSOCIATION OF AMERICA  
 4525 Ravenswood Ave., Dept. RN-18, Chicago, Ill.

RADIO TRAINING ASSN. of AMERICA  
 Dept. RN 18, 4525 Ravenswood Ave., Chicago, Ill.  
 Gentlemen: Send me details of your Enrollment Plan and information on how to learn to make real money in radio quick.

Name.....  
 Address.....  
 City..... State.....

*Every DX'er Needs This Clock—*  
**WORLD TIME**  
*at a glance!*



You're here ON TIME with a World-Wide clock! One quick glance gives you Standard or GMT time, accurately—instantly—for any one of the twenty-four time zones around the world.

Self-starting, 24 hour, genuine Waltham movement. Dials plainly marked for direct reading. For 110 volt, 60 cycle, AC. A beautiful, practical instrument you'll be mighty proud to own. Base removable for flush-mounting in your panel. (Hole size 3 11/16"). Only \$9 net. See your jobber TODAY!

**GORDON NAME PLATES ANTENNA TUNING**

A complete line of 122 overlasting, chromium plated name plates for Transmitter, Sound and Test equipment. Available in two sizes. Write for listing and low prices.

**GORDON SPECIALTIES COMPANY**  
 440 S. Dearborn Street • Chicago, Illinois

**TRIAD**  
 Radio Tubes  
**Triple Checked for Quality**  
 TRIAD MFG. CO., INC.  
 Pawtucket, R. I.  
 The Quality Name in Radio

The "Ham" Shack

(Continued from page 409)

in the buttons after which they may be repaired only by repacking, a job which is almost as expensive as the microphone itself.

A number of crystal microphones of both diaphragm and sound cell types are manufactured by the Astatic Microphone Laboratories, Inc., of Youngstown, Ohio. The characteristics of these units follow:

**Model D104**

Output level.....-56 db  
 Type.....Single diaphragm crystal  
 Frequency range  
 Essentially flat from 60 to 4,000 cycles  
 Dimensions.....3" diameter, 1" thick

**Model D2**

Output level.....-64 db  
 Type.....Double diaphragm crystal  
 Frequency range  
 Within 2 db from 50 to 6,000 cycles  
 Dimensions.....2 1/2" diameter, 5/8" thick

**Model K2**

Output level.....-64 db  
 Type.....Double diaphragm crystal  
 Frequency response  
 30 to 6,000 with 10 db rise at 10,000 cycles  
 Dimensions  
 Cylindrical 1 1/4" diameter, 2 1/2" high

More than eight microphones of various types are offered the amateur by Shure Brothers, of Chicago. Their models are:

**Model 70S**

Output level.....-47 db  
 Type.....Single diaphragm crystal  
 Frequency response  
 50 to 6,000 cycles (Designed for voice work only)  
 Dimensions.....2 3/4" diameter

**Model 700A**

Output level.....-50 db  
 Type.....Curvilinear diaphragm crystal  
 Frequency response.....40 to 10,000 cycles  
 Dimensions.....Swivel head, 2 3/8" diameter

**Model 701A**

Output level.....-50 db  
 Type.....Curvilinear diaphragm crystal  
 Frequency response.....40 to 10,000 cycles  
 Dimensions  
 3 1/2" high, 2 1/8" wide, 1 3/8" deep

**Model 702A**

Output level.....-50 db  
 Type.....Curvilinear diaphragm crystal  
 Frequency response.....40 to 10,000 cycles  
 Dimensions  
 Spherical with 360 degree pickup, 2 1/4" diameter

**Model 70H**

Output level.....-60 db.  
 Type.....Single diaphragm crystal  
 Frequency response.....30 to 10,000 cycles  
 Dimensions.....3" diameter, 1 1/4" thick

**Model 750A**

Output level.....-47 db  
 Type.....Single diaphragm crystal  
 Frequency response.....50 to 6,000 cycles  
 Dimensions  
 "Military Type" to fit in hand 3 7/8" high, 1 3/4" thick

**Shure "Tripolar"**

Output level.....-54 db  
 Type  
 Crystal with controllable direction characteristics controlled by a three-position switch  
 Frequency response.....40 to 40,000 cycles  
 Dimensions.....5 1/2" high, 2 1/2" diameter

**Model 85A**

Output level...68 db below 1 volt per bar  
 Type.....Sound cell crystal  
 Frequency response....30 to 10,000 cycles  
 Dimensions  
 3 1/2" high, 2 7/8" high, 1 3/8" deep

**Model 3B**

Type.....Double button carbon  
 Frequency response....50 to 4,000 cycles  
 Dimensions.....3 1/2" diameter

**Model 5B**

Type.....Double button carbon  
 Frequency response....50 to 5,000 cycles  
 Dimensions.....3 3/4" diameter

The Turner Company of Cedar Rapids, Ia., makes a number of popular models, principal among which is the VT-73. Its characteristics are:

Output level.....-47 db  
 Type.....Single diaphragm crystal  
 Frequency response....40 to 8,000 cycles  
 Dimensions.....2 3/8" diameter

A number of velocity type microphones designed for amateur use are manufactured by the Bruno Laboratories, Inc., of New York City. These include:

**Model A**

Output level.....-50 db  
 Type.....Static-type velocity  
 Frequency response  
 30 to 14,000 cycles (adjustable)  
 Dimensions...6" high, 2 1/4" wide, 1 1/2" deep

**Model WS**

Output level.....-45 db..  
 Type.....Static-type velocity  
 Frequency response  
 30 to 14,000 cycles (Adjustable)  
 Dimensions...7" high, 3 3/8" wide, 2" deep

Both of the above type microphones require a polarizing voltage adjustable from 150 to 350 volts.

**Model VD**

Output level.....-69 db  
 Type.....Velocity  
 Frequency response....50 to 10,000 cycles  
 Dimensions  
 6 1/2" high, 2 3/8" wide, 1 1/2" deep

**Model VR**

Output level.....-67 db  
 Type.....Velocity  
 Frequency response....50 to 12,000 cycles  
 Dimensions  
 7 1/4" high, 3 3/8" wide, 2 1/8" deep

**Model WM**

Output level.....-65 db  
 Type.....Wide angle velocity  
 Frequency response....50 to 12,000 cycles  
 Dimensions  
 7 1/4" high, 3 3/8" wide, 2 1/4" deep

**Model PR**

Output level.....-51 db  
 Type.....Velocity  
 Frequency response....30 to 14,000 cycles  
 Dimensions...9" high, 4 5/8" wide, 3 3/8" deep

A number of velocity microphones are manufactured by the Amperite Company. These include inexpensive models as well as broadcast units. They are:

**Model RBHK**

Output level.....-65 db  
 Type  
 Velocity, available for both low and high impedance input  
 Frequency response....40 to 11,000 cycles

**Model RAL**

Output level.....-68 db  
 Type.....Velocity  
 Frequency response....40 to 9,000 cycles

**Model SR-80**

Output level.....-64 db  
 Type.....Velocity



Frequency response... 30 to 12,000 cycles

A number of dynamic type microphones recently have been put on the market. These include models made by the Western Electric Company and the RCA Manufacturing Company, Inc., of Camden, N. J. The ratings on these microphones are:

**Western Electric Model 633A**

Output level.....-65 db  
 Type....."Salt Shaker" dynamic  
 Frequency response...40 to 10,000 cycles  
 Dimensions  
 Cylindrical housing: 3½" long, 2" in diameter

**RCA "Aerodynamic"**

Output level.....-68 db  
 Type.....Pressure operated dynamic  
 Frequency response...100 to 6,000 cycles  
 Dimensions...3" high, 2½" wide, 3¾" deep

RCA also makes a double button carbon microphone, the ratings of which are:

Output level.....-63 db  
 Frequency response...50 to 6,500 cycles  
 Dimensions  
 6" high, 3½" wide, 2" deep (in stand)

An extensive line of microphones also is manufactured by the Brush Development Company, of Cleveland, Ohio. They are:

**Model B1**

Output level.....-66 db  
 Type.....Sound cell crystal  
 Frequency response...50 to 10,000 cycles  
 Dimensions...3½" long 1¾" wide ¾" deep"

**Model BR2S**

Output level.....-66 db  
 Type...Sound cell using four crystal plates  
 Frequency response...60 to 7,000 cycles  
 Dimensions...Ball shaped 2½" diameter

**Model BL1**

Output level.....-72 db  
 Type...Sound cell using four crystal plates  
 Frequency response...60 to 7,000 cycles  
 Dimensions  
 Lapel type, 1¼" high, 1¼" wide ¾" deep

**Model B2S**

Output level.....-66 db  
 Type.....Sound cell crystal  
 Frequency response...50 to 10,000 cycles  
 Dimensions...3½" high, 1¼" wide, ½" thick

**Model G2S2P**

Output level.....-70 db  
 Type.....Sound cell crystal  
 Frequency response...40 to 10,000 cycles  
 Dimensions...3" high, 1¼" wide, 1½" deep

**Model G4S6**

Output level.....-64 db  
 Type.....Sound cell crystal  
 Frequency response...40 to 12,000 cycles  
 Dimensions...4½" high, 1¾" wide, 1½" deep

When used with a good speech amplifier, any of the above microphones will give excellent results in an amateur transmitter. The output level of the microphone will help in determining what amount of gain will be necessary in order to fully modulate a transmitter of a given amount of power. If a speech amplifier on hand does not have sufficient gain for the type of microphone used, a simple one or two stage pre-amplifier may be installed. It will be found with most velocity and dynamic types additional amplification will be necessary unless the speech equipment provides a gain of about 120db. or more.

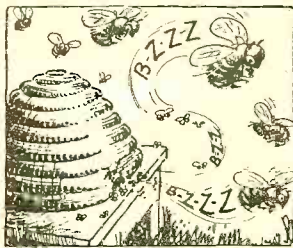

**HUM IS EXPECTED**

around bee hives, but should not be tolerated in audio design.

Kenyon Hum Bucking Transformers are priced as low as \$2.40.

Catalogs describing the various Kenyon audio and power components obtainable from your local dealer.

**KENYON TRANSFORMER CO., Inc.**

840 Barry St., New York, N. Y.

**The New ALLMETER for Rapid, Accurate Measurements**



**27 Instruments in 1**

**Operates on 90-130 volts—60 cycle operation**  
 The ALLMETER, with 1,000 ohms per volt sensitivity, is a multi-purpose tester accurately measuring A.C. and D.C. volts and currents, also capacity, decibels, resistance and inductance. It features:  
 Volts and Milliampere, 15-15-750 (A.C. and D.C.)  
 Capacity, .01-50 mfd., including electrolytics  
 Decibels, for total change of 42 db.  
 Resistance, .03-500 and 500-500,000 ohms.  
 Inductance, 5 to 1,000 henries.

**\$10.40**

For complete technical details on the ALLMETER and other SUPERIOR TEST INSTRUMENTS write for Catalog RN-18

ORDER DIRECTLY FROM THIS ADVERTISEMENT!

**SUPERIOR INSTRUMENTS COMPANY 136 LIBERTY STREET Dept. RN-18, New York, N. Y.**



**FREE**

**The Finest Radio Catalog ever printed . . .**

Just off the press! Complete line of Sound Equipment . . . the latest and finest made. First Licensed Transmitter . . . built by the Hallicrafters and licensed by R. C. A. Newest and finest in "Ham" Receivers, parts and accessories. Everything for the Service Man, Amateur and Experimenter. All at rock bottom prices . . . all sold on Wards convenient Monthly Payment terms. Send for your copy today!

**MONTGOMERY WARD • CHICAGO**

- Sound Systems and Equipment
- Inter-Communication Systems
- Automobile Radios and Supplies
- "Ham" Transmitters and Parts
- "Ham" Receivers and Supplies
- Testing Instruments and Books
- Replacement Parts and Supplies

MONTGOMERY WARD, Dept. RN-11, Chicago, Ill. Send me my Free copy of Wards new 1938 Radio Catalog. I am particularly interested in the equipment checked at left.

Name .....

Address .....

City..... State.....





**AmerTran's reward for continuous research, technical improvements, quality materials and fine engineering is world-wide acceptance of the AmerTran Transformer. Amateurs, as well as experienced engineers everywhere, have learned to rely upon it for clear, natural amplification. Frequency characteristics are exceptionally uniform; filter types give full inductance with rated d.c. flowing; power units have better than 10% regulation. Consult our Bulletin 1002 for complete details. Write:**

**AMERICAN TRANSFORMER CO.  
178 Emmet Street Newark, N. J.**

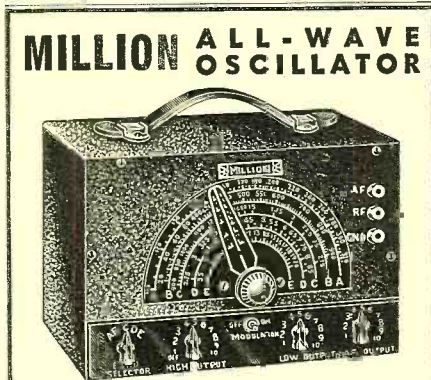

**A.C., D.C.  
6 BANDS—100-25,000 K.C.  
SEPARATE AUDIO  
LINE FILTERS ..... 19.95 NET**

Write for literature on our complete line of test instruments.

**MILLION RADIO AND TELEVISION LABORATORIES  
577 N. UNION ST., CHICAGO, ILL.**

**RADIOS... SAVE UP TO 50%**

**DEAL DIRECT... FACTORY PRICES!** Many models to select from: AC DC, All-Wave, armchair models; automatic tuning; car radios; Farm sets that operate like city radios! Send postcard for NEW Bargain Catalog FREE. 30 DAY TRIAL plan and agent-user proposition.

**30 DAY TRIAL 6.98 UP**

**GOLDSTONE RADIO CO. DEPT. A1, DEARBORN, MICHIGAN**

*Free Catalog*

**RADIO ENGINEERING.**

broadcasting, aviation and police radio, servicing, marine radio telegraphy and telephony. Morse telegraphy and railway accounting taught thoroughly. Engineering course of nine months' duration equivalent to three years of college radio work. School established 1874. All expenses low. Catalog free.

Dodge's Institute, Oak St., Valparaiso, Indiana

**THE AMATEUR OBSERVER**  
*Conducted by W2JGR*

**F**OR the benefit of American amateurs, the calls heard listed this month are mostly those reported by observers in distant countries. This publication of lists sent in by foreign listeners will also give American observers an opportunity to see what their foreign DX brothers are accomplishing.

\* \* \*

It becomes more and more imperative that lists of calls heard on the 10 and 20-meter bands be limited to really DX calls. Many of the reports received persist in listing 20-meter stations only a few hundred miles distant. Three thousand miles would seem to be a logical dividing line for DX on these two bands.

\* \* \*

The following two observers would like to correspond with other observers: Ray Bayer, 2314 La Salle Street, Racine, Wis., and James Arp, 706 Penn Street, Williamsport, Pa.

**CALLS HEARD**

By W2JCY, Laurence M. Cockaday, 547 Second Avenue, North Pelham, N. Y.

10 meters: D3CSC-5, D4YLL-9, GDF-7, AOR-5, QET-9, F3GR-9, HL-8, DN-7, LE-9, 8LX-9, XW-8, OD-9, OW-7, PY-7, WKS-9, ON4FE-9, AU-1B-7, VU-7, NC-8, YL2CD-7, OK2RM-7, WV-7, OPS-8, 8VA-9, LAIY-9, EI2L-9, 9I-9, SPIHH-9, 8MOL-9, YH-7, VV-7, PAOBE-9, BD-7, FBS-9, G2DC-9, IT-9, PL-9, AU-7, MF-9, 5KH-9, VM-9, BI-9, BM-8, BY-5, CY-7, ML-9, 6WU-8, QB-9, VY-9, DH-9, BW-9, GF-7, LK-9, GO-7, LL-9, GS-9, 8OC-7, GW2UL-9, NG-8, SCT-9, GM6RG-9, XI-9, NX-7, UZNE-9, 9ML-9, CTIAY-8, CNSAV-9, FYIO-9, XWLAG-9, GE-9, A-7, K6MVV-9, OOE-9, LCV-9, BNR-7, MHV-8, OA4J-9, HK1JD-9, 4EA, PY2AC-8, HR4AF-9, K5AT-9, AG-9, LU3DH-9, 5FG-5, AN-6, 9BV-9, VP3BG-7, 5GM-9, 6ZJ-8, VU2CO-8, AU-7, 6SW-5, ZS1AH-7, PAJ-8, I-7, ZU5Q-5, 6I, P-9, ZT2G-8, 6AB-6, XY-5, IJF-7, 5CC-5, SCF-4, JMNS-8, FMSAA-6, VK2GU-9, ADE-7, 4TK-7, 5KO-8, HG-5, 6MU-8, ZLIDV-7, 2AL-7, 4AC-8, ZE1JJ-7, VO3X-7, 4C-8, HH5PA-8.

By N. C. Smith, "Somerden", 53 Birch Tree Road, Petts Wood, Orpington, Kent, England.

10 meter phone: W1EDW-6, COO-5, KXA-4, 2KXR-6, IOX-8, FH1-7, JIL-8, KAX-6, HFS-6, ICY-8, JOC-5, 3FVL-5, EGA-3, 4EED-9, BYY-9, FT-7, ERH-5, SNYD-4, AHC-4, VE1DR-5, 2KX-3, CNSAV-7.

10 meter c.w.: W1KTF-6, KOF-4, 2HGO-6, BHW-5, 3EXB-3, SAZD-8, CKY-5, SV1RX-6, 8JFB-7, FMSAF-3, OEIEK-5, FA3JY-4, 8JO-8.

20 meter phone: W4OA, IF, BPD, OIH, EF, OC, CYU, SNFF, HQE, YL2CC, VO6L, CNSAM, SV1CA, CO2RA, 6OM, VE1LR, 3JV, EO, KAIYL, MH, SM5ST, 6WR, 7WA, LA5N, 6P, N, 7K, HA4A, SU1AX, SG, LU5AN, 8AB, VP6TR, PY1FR, ES5B, D, HH5PA, NY2AE, TF3P.

20 meter c.w.: W5FT, SCUO, LYQ, 9FNK, LIR, OT, HKO, PXZ, ZL3AZ, 4GM, AF, GA, ZSIAN, SU1WM, VK2UD, VN, YL, 4EL, UK5HA, VU2AN, K5AA, HS1BJ, ZUID, U5RC, FISAC, VE3FB.

By Ken Weale, 17 Cardinal Crescent, Dewsbury Road, Leeds 11, Yorkshire, England.

20 meter phone: W1JUG, 2JT, 2GVX, 2FGV, 21PR, 2DH, 2IWT, 2JK, 2HFS, 2ZC, 2BSY, 2IXY, 2ETI, 3EKU, 3GAO, 3MD, 3DWE, 3FGN, 3FH, 3FOJ, 3EOZ, 3BIH, 4CYU, 4DRD, 4UK, 4EE, 6BW, 8ABC, 8OAR, 8LPI, 8OMJ, 9PDI, K4ENY, 4BDA, VOI, VE1CN, 1DX, IAR, ICR, PY1FR, 2BA, CNSAM, YV5AA, 5AE, LU4KA, 5CZ, VP6PR.

By Renato Brossa, at IIBAG, Chieri, Turin, Italy.

20 meter phone: SU1FS, 1FG, VE1CL, 2HG, W1BLO, 1VA, 1QM, 1GAN, 2DH, 2ZC-9, 2IH, 2ETI, 2HYH, 2AT, 2GS, 2WGO, 3CH.

4APA, 4CDO, 4DCR, 9ESO, 9LFU, T11AH, 2F, 3AH, 3CO, CO2AA, 2OK, 2RA, LE1AB, LS1AB, LU6ET, YV5EB, TY1FR, CE1AR, OR5PZ.

By Eric Gertenbach, 3 Molteno Street, Uitenhage, Cape Province, South Africa.

20 meter phone: W1JFT-4, 2AZ-6, 2IUU-8, 2AZI-5, 3DRA-6, 3FGN-5, 4HX-8, 5ZS-6, 6BPN-7, 6LYM-8, 6ISH-9, 6TT-9, 6CDO-7, 6CTG-7, 6AMG-7, 6NNR-9, 6BAW-5, 6IKR-5, 6GCT-9, 6AL-5, 6EJC-6, 6PB-7, 6IHR-9, 6IRX-6, 6AH-7, 6OSY-9, 6GM-6, 6MRP-7, 6OD-7, 6CNA-8, 6HOW-9, 7CEO-9, 7FOK-7, 7VA-5, 7ABF-7, 8DLD-9, 8ANO-9, 9TIZ-6, 9BAQ-8, 9UEL-7, LU3EJ-5, 5CZ-8, FBSAH-9, 8AB-7, PK1FF-8, 1MF-6, 2WL-7, 3AA-7, 3WI-6, 6HI4, PY2ET-6, TI2KP-5, XZ2DY-4, PAOUN-5, 2DY-4, VE4MO-7, 5VO-9, ZE1IA-9, 1JR-9, ZS3E-9, CR7AU-9, 7AK-4, KAIME-7, 1DT-6, K6NR-7, 6NZQ-7, 6OOE-5, VS2AK-4, 2HS-5, 2CE-4, 2ABD-3, 4JX-4, 6MW-7, K7FBE-5, 4DDH-8, NY2AE-7.

By Oscar Westman, 24 Lawrence Road, Maitland, Cape Town, South Africa.

W2IC-8, 3AMH-7, 4DSY-8, 5EEM-7, 6ORR-7, 6AB-7, 6CU-9, 6ISH-9, 6FTUS-8, 6JKR-8, 6IPH-8, 6HOE-8, 6MBQ-7, 6CTG-8, 6OHK-8, 6FMY-7, 6LYM-8, 7DC-8, 9CH-9, 9FOP-7, 9FJ-7, YR5AP-8, ZS2J-9, 5AB-9, ZUIB-9, 6E-9, 6N-9, 6AF-9, VE4WJ-8, 4KZ-8, 5JK-8, 5IK-8, K4SA-8, 6JK-8, KAIME-9, ZT6Y-9, VQ8AB-8, FBSAB-8.

By E. H. Walker, 23 Burlington Road, Chiswick, London, W4, England.

20-meter phone: SV1CA, 1KE, TG2S, Y12BA, FT4AR, 4AN, W1BLO, 1BTL, 1CRW, 1IFD, 1JUG, 1AJZ, 1JZA, 1CND, 1EBO, 1ADM, 1GED, 1APPA, 1FUJ, 1DMV, 1BBX, 1IGX, 1IED, 1GBX, 1GYZ, 1HZO, 2HCE, 2IXY, 2ZC, 2UK, 2JKO, 2GIZ, 2BZ, 2CWC, 2DH, 2AZ, 2JT, 2HYT, 2AD, 2GVC, 2AWL, 2AVY, 2GSC, 2HX, 2HS, 2GO, 3FIH, 3DLL, 3ANH, 3BMA, 3EFS, 3FIJ, 3FAM, 3CC, 3EOZ, 3DRA, 3BEI, 3DYE, 3BIH, 3WN, 3CRI, 3HUQ, 3BSY, 4DHL, 4DSY, 4IS, 4CYU, 4EKL, 4EEZ, 4EEE, 4APK, 4AKY, 4EHG, 4WZ, 5EHT, 5ZS, 6CQI, 6LYM, 6AL, 6AM, 8NXY, 8JNU, 8OAR, 8FNN, 8BYF, 8IUG, 8BKA, 9ZDO, 9BBU, 9YGC, 9ATZ, 9FSY, 9MCD, 9NGZ, YV5AA, K4ENY, FA3JY, 8IH, LU3EJ, 5CZ, 9BV, VK2XU, 3KX, OE6MP, PY2AL, VE1JA, 1LR, 1CA, 1GP, 2HE, 3AGT, NY2AE, CE1AO, 3CO, HK3IA, TI2FP, 2AV, CO2AY, 2UG, 2RA, 2JJ, 2KL, 7HF, 7VP, HC1FG, 1JB, SV1KG, 1RO, 1SG, SMA, CNSMB, SAM, 8AL.

By W1IJ, Owen Shepherd, Jr., Madison, Conn.

5 meters: W1BIE-7, 1API-7, 1JLK-8, 1KNM-9, 1KTP-5, 1BCR-9, 1KIT-6, 1FHN-9, 1JSD-6, 1KOK-7, 1KPN-7, 1AVV-7, 1ICDR-5, 1EYM-5, 1KR-6, 1JVO-7, 1DEI-7, 1GDI-6, 1EER-8, 1HDF-7, 1JZJ-7, 1JUZ-3, 1ZE-8, 1FUB-6, 1KOR-7, 1BRL-4, 1CBG-9, 1CDA-4, 2CFT-4, 2IYL, 2HG-4, 2ICA-4, 2DTH-5, 2ICY-8, 2BNH-4, 2ST-7, 2MO-6, 2CUZ-5, 2EWO-5, 2DPG-4, 2EIP-6, 2HVK-6, 2HEI-8, 2AMJ-7, 2COT-5, 2HNW-5, 2HHN-4, 3AC-7, 3EZH-5, 3GQS-6, 3EPPN-5, 3AXR-6, 3FBH-4, 3FVR-6.

By Claud H. Roberts, 30 Crogsland Road, Chalk Farm, London, England.

20-meter phone: W1BLO-8, 1ADM-4, 1APA-7, 1ADI-8, 1GED-8, 1TW-7, 1HKK-5, 1FNL-6, 1JFG-7, 1CCZ-0, 1BBX-6, 1ED-4, 1FH-9, 2DH-9, 2IJG-6, 2AVS-6, 2DYR-4, 2GSC-4, 2ZC-9, 2HUQ-4, 2FOAS, 2HNP-6, 2CFH-4, 2KLI-9, 2HFS, 2HYV-8, 2CFU-8, 2IKP-6, 2KFH-6, 2HFS-7, 3EWN-8, 3EUK-6, 3GFU-9, 3GSU-7, 3FGN-8, 3BEI-6, 3MD-9, 3CRI-9, 3FTI-9, 3ANH-4, 4DSY-7, 8HFE, 8YVF-6, 8NUN-9, 8DOL-6, 8MPX-8, 8BBU-5, SU1KG-9, 1SG-9, EA9AH-6, CNSAM-9, VO2Z-8, VO1T-6, LU5CZ-6, CE2AB-6, CO6OM-9, VE1JA-6, 1GR-4, 1GP-4, 1LR-6, 2RU-4, 2HE-6.

By H. Westman, "Stony Hill", Listening Post, Huguonot, Cape S. Africa.

20-meter phone: F3GR-5, G2HQ-5, 6XR-6, HS1BJ-7, KAIME-9, 1DT-7, K6OQE-6, LU3EJ-6, 5CZ-9, 7AG-7, 7BH-7, 9BV-8, OA4AL-5, PK1RI-6, 2WL-6, 2WJ-6, 3AA-8, 4WS-7, VE4KZ-8, 4MO-6, 5VO-8, VK2HS-5, 2OG-6, 2ABD-8, 2AZ-5, 2VQ-6, 2HF-5, 2IU-6, 2NS-8, 3AL-6, 3VD-7, 4BB-5, 4JU-6, 5GF-6, 5GM-6, 6MW-8, VS1AI-6, VU2CQ-9, W1CRW-8, 3ANH-8, 4DSY-7, 5FDE-6, 5CHU-8, 6ITH-6, 6LLQ-9, 6NNR-8, 6ABF-6, 6KY-9, 7CYP-6, 9ARL-6, 9FAA-6.

By H. F. Hamilton, "Glenara", Shelveys Way, Ladworth, Surrey, England.

10 meter phone: K4EIL-6, 6MVV-4, TI2FG-6, VE2KX-5, VU2CQ-4, ZS6AJ-5, W5DOK-4, 5EYM-5, 5FDE-5, 5FNH-4, 6ITH-4, 6NLX-4, 7EHT-4, 9YOC-5.

10-meter c.w.: FMSAA-6, SOI-4, HK4AE-4, HR4AF-4, HS1BJ-4, K5AC-5, OA4J-4, SV1RX-6, UK1CC-8, U2NE-9, 9MF-5, VE1HK-6, 2BG-5, 2BV-7, 2ID-7, 2KA-5, 3ER-5.



Official Listening Post Observers for the Amateur Band

United States

California: Jack Flagg, G. C. Gallagher, W. Hallgren, Robert H. Hibbs, Harry Honda, Arthur Schelling, William Wanamaker.

Colorado: M. J. Markuson. Connecticut: George L. Jones. District of Columbia: Charles J. Havena.

Illinois: Rodney Newkirk, Robert Lee Nichols.

Indiana: Gideon Brainerd, Garland Haas.

Louisiana: Wilbur T. Golson.

Maine: H. Francis Shea.

Maryland: John E. Quintrell, Jr.

Massachusetts: Gerald Swanberg

Michigan: Milton Hawley

Minnesota: Burton W. Bostad

Missouri: Raymond W. Sahlbach

Nebraska: Al Bettinger, William Dean Noyes

New Jersey: George Leslie Allen, George Kneer, Nelson Leckliker, Ray Service, Paul Wunsch, Jr.

New York: Walter E. P. Bishop, Elmer R. Fuller, L. F. Gallagher, Julian D. Hirsch, Michael Kelly, Harry E. Kentzel

North Carolina: William W. Oglesby, Jr.

Ohio: Homer Bohlender, Wilbur Croston, George Sangrik, Earnest Uney

Oklahoma: Hugh Robinson

Oregon: John Frederick, Herbert A. Gilbaugh

Pennsylvania: Albert Augustine, Clarence Hartzell, Thomas P. Jordan, Roger Legge, Jr., Ernest Pavlidis

Texas: William Sloan

Vermont: E. H. Davenport

Virginia: Robert Hatcher, Chris Davis Jaffe

Wisconsin: Ray Bayer, Joseph V. Rudolph

Foreign

Australia: Frank E. Taylor

Canada: Bernard J. Clancy

England: J. S. Dunn, H. L. Hirschberg, E. J. Margrie, Claud H. Roberts, N. C. Smith

New Zealand: J. C. Sibbin

Poland: P. Piorko

3XK-4, 4AW-4, 4JS-5, 4JV-5, 5HE-4, 5HR-5, VK2GU-4, 5KO-4, VSTMB-6, VU2CO-8, 2FV-4, YR5CF-5, ZE1JJ-4, ZL2GO-4, ZUGAC-5, W5AFK-4, 5AFX-5, 5CCU-4, 5CUA-4, 5DRZ-6, 5ENZ-5, 5FDE-5, 5FFW-7, 5QL-5, 6BAM-4, 6BDO-5, 6DUC-5, 6GNQ-4, 6GNZ-4, 6PZL-8, 6QP-5, 6OR-4, 7AMX-5, 7ANJ-5, 7AVV-6, 7BKF-4, 7EKA-4.

20-meter phone: CO7HF-6, 7VP-7, HC1FG-6, 1JB-6, LUIDA-4, 5CZ-5, 9BV-5, 8AB-5, OAA-5, PY1BC-4, 1DK-5, 1FR-5, 1GU-4, 2GC-4, 2LA-4, 5AO-5, T12FG-6, VK2HP-5, 2OQ-4, 2PE-4, 2XR-4, 2XU-5, VK3AL-5, 5GO-5, 3KX-5, 3PE-5, 3WA-4, 5AL-6, 5AW-4, 5TI-4, YV5ABP-4.

20-meter c.w.: FMSAD-7, K4DUG-7, 5AR-5, GNCW-5, MX2B-5, PY2AL-6, 2KX-6, VE3FB-7, 5KI-4, VK2CP-5, 2CW-5, 2PV-3, 2TF-5, 2UL-7, 3EN-7, 3HT-5, 3OC-7, 3PH-7, 3VI-5, 4BB-4, 5HU-5, 5MY-5, 5WS-5, 7CL-4, 7KR-6, ZL2CI-5, 3AB-5, 4GN-5, ZS6AU-5. By R. T. Coates, 54 Chelsea Road, Southsea, Hampshire, England.

10 meters: VU2CO, W5VV, 6NLS, 6ITH, 6CKR, 9AGO, 9SYG, 9UPX.

20 meters: KA1ME, 1JR, VK2XU, 2VV, 3XJ, 3AL, 5AW, VU2BG, PK1ZZ, 3WI, XE2FC, Y12BA, CE1AH, VE5OT, 5JK, VS2AK. By H. L. Hirschberg, 38 Marney Road, London, S.W.11, England.

W1ADM-5, 1EBO-4, 1CZ-5, 1BLO-7, 1QM-8, 1JFG-5, 1JBA-7, 1IFA-4, 1GED-7, 1AQM-7, 1XVK-5, 2FTB-7, 2AZ-6, 2GLL-6, 2DH-7, 2GWW-6, 2IXY-6, 2AWL-8, 2FOA-7, 2CMU-6, 2UK-7, 2GIG-5, 2GIZ-4, 2JK-4, 4AKY-8, 5FAG-7, 61FH-7, 8GLY-8, 8HUR-8, 9KK-6, 9ELL-4, FT4AN-8, SUI5G-6, GM-5NW-8, VE1CN-5, 1BC-5, 1LR-7, CO2LN-5.

By G. A. Clayton, Winscombe, Somerset, England.

20 meters: W1APA-7, 1BLO-6, 1FOV-7, 1JFG-7, 1DDX-8, 2DH-8, 3EUZ-7, 3EOZ-7, 3FTO-6, 4CYU-7, 4DZF-7, 4DSY-8, 6TD-6, 8IOE-7, CN8AM-7, 8AI-7, SUI5G-9, 1KG-9, VE1CR-8, FT4AN-8, ZBIE-7, F3BHC-8, OZ3U-8, LU5UA-6, KA1ME-5, VO4CRE-7. By P. L. Stiles, 20 Temple Sheen Road, East Sheen, London, England.

20 meters: VO1G-4, VS2AO-2, SUI5G-7, WIJFG-7, 1DAA-5, 2DH-5, CN8AM-7.

By G2CYW, Braintree, Essex, England. 20-meter phone: WICEW, 1JFG, 1CMD, 1JZA, 1JG, 1JUG, 1APA, 1ADM, 1AVM, 1KCK, 1NU, 1DET, 1BLO, 1T00, 1WE, 1KRD, 1LI, 1KKT, 1AXA, 1FB, 1BV5, 1DYA, 1JVE, 1BBF, 1OM, 1JED, 2DH, 2HCE, 2BII, 2CCM, 2IUV, 2BR, 2JK, 2ZC, 2BBI, 2IDQ, 2BQV, 2BHI, 2WW, 2BFB, 2AZ, 2EIZ, 2HGK, 2FBD, 2FOA, 2MY, 2TOT, 2YK, 2CIF, 2IXY, 2IBO, 3MD, 3BGT, 3BEI, 3ZF, 3EWN, 3BRI, 3CHE, 3HN, 3MFD, 3FAM, 3EU, 3BYU, 3WM, 3ASG, 3EFS, 3FSD, 3BMA, 3FIH, 3DX, 3AIR, 3BVU, 3GY, 3FTI, 3DLL, 4HX, 4BPD, 4ACU, 4IS, 4AKY, 4CYU, 4EBW, 4DCP, 4EOK, 4DRD, 5ZS, 5BCU, 6LGX, 6CQI, 6MTZ, 6QCH, 6FNN, 8AU, 8HP, 8HEQ, 8OAR, 8FHB, 8TKP, 8PMA, 8SKS, 8TY, 8HUL, 9BDU, 9PYS, LA6N, OE6DT, YL2CC, FSQD, IIMX, IMI, CTIAY, 1AI, 2AB, LA1G, OZ3U, CN8AL, SV1CA, SUI5G, ZB1H, 1L, 1E, ES5D, HA4A, SV1KE, F3CD, FT4AL, SUICH, LA1F, VK3ZZ, HC1JW, NY2AE, VP9R, VSIAR, KAIYL, VS2AK, HK1D, YV5AA, VE1EI, 2DC, 2BG, 3KX, VO1P, 2V, 6L.

By G. C. Gallagher, 18 Delano Avenue, San Francisco, Calif.

20 meters: VK2AX, 3AL, 4JU, PK1JW, ZP6Y, ON4VK.

By Thomas P. Jordan, 1523 N. Main Avenue, Scranton, Pa.

10 meter phone: ZUGP-9.

20 meter phone: VO6L-9, 6D-8, ON2QY-9, G5JO-7, VP9R-9, ZUGP-7, FR8VX-5.

By Paul Wunsch, Jr., 387 Clifton Ave., Clifton, N. J.

20 meters c.w. and phone: ON4DM-6, 4MY-6, 4RX-7, UIAD-4, LU4BL-7, VP9R-6, YV2CU-3, 5ADA-8, 5AA-8.

By John Frederick, P. O. Box 325, West Linn, Oregon.

20 meters: CE1AO, 3DW, HC1JB, 1FG, OA4AL, LU1HI, YV5AJ, HK3MG, CO2LY, 2RA, 2CC, ES5D.

By L. F. Gallagher, 307 East 17th Street, New York, N. Y.

20 meter phone: VO6D-9, 6JO-9, VP9R-9, 9G-8, 9O-7, VS6AK-5, VU2CO-7, F3VX-7, 8OD-7, 8OO-8, G2PU-8, 2HF-5, 2PO-3, 2OA-8, 5BI-6, 5MI-5, 5ZA-5, 5NI-4, 5LU-7, 6BA-7, 6HW-6, 6IF-7, HH5PA-9, HK2AL-4, EI2L-7, 4F-6, CX1CB-8, 1CX-8, 3BL-6, G16TK-8, ZE1JR-5, 1IF-7, HC1JD-9, PK4MY-7, PY1FR-8, 1DK-7, 7AY-8, NY1AA-7, 2AA-7, 2AE-6, T12FT-7, 2FG-7, 2CT-8, 3RE-8, YL2TC-8, CE3AA-8, ZD1JR-7, XU3FK-6, EA8AE-8, SUI5G-7, IUGAN-7, 9BB-9, 9DD-8, ON4KM-7, YV5AA-8, OA4V-8, 4A-7, 4N-8, 4AL-9, CTIAY-7, YR5DY-7, EA1AY-7, 7AI-6, ZD6AM-8, GYP-9, 6YA-7, 6AJ-9, ZU1CM-8, 6AF-8, 6AS-7, ZS6AJ-7.

20 meter c.w.: K5AA-8, 5AG-7, 6KVX-8, 6CQA-5, 7FYI-8, 7DNZ-5, PK1MX-7, 1CI-6, 4RF-8, OZ7TU-8, SE-7, OK2HX-8, 2H-6, D4XBG-9, 4YBF-9, 4VRR-7, LY1J-8, 1AF-6, FB8RC-7, 8AC-6, OA4R-9, ON4ZC-8, OX2Y-6, G2HC-4, 5BS-6, 5GX-7, 6LK-7, 6GH-7, 8KS-7, GM6KS-7, 6KH-8, 6VI-6, FR8RE-7, 8HX-7, STM-6, U2AI-7, 3KO-8, 4AG-7, 9AC-8, H1GL-7, 8G-8, OH3NR-9, 3NP-8, 3OI-9, HK1Z-7, H12LS-5, SM7UC-6, VK2TC-2, 2IC-3, 3GU-3, 3SG-6, 3RT-4, 4US-5, 6SA-6, EI4J-9, 8K-8, 8G-7, 8Y-7, LU6DID-8, 6AU-8, 6AX-7, 6DIK-7, OE8AH-6, YT7CI-8, 7VN-8, YR5AR-9, FISAC-8, F3CY-7, 3AM-7, 3BI-6, 6AK-6, 8X1-5, 8VH-5, 8LU-8, 8RI-7, 8LU-9, 8IL-7, SUIKE-5, ISG-5, 1CO-4, 7TY-8, 2JL-6, 2JJ-7, 5CC-6, 5LX-8, PY1BR-4, 2DO-4, 2DS-4, 7AJ-7, ZU2C-8, ZT6AL-8, ZS4I-6.

By John B. McGowan, 66 Bedford Road, Woburn, Mass.

20 meter phone: CT1AY, CN8AL, EI2J, 2L, FT4AN, HC2CJ, HH2B, KA1ME, LA1F, LU8EJ, 8AB, ON4HW, 4PA, 4SS, OA4R, PAOAD, OBE, ONP, PK1GL, SUIRK, SV1KE, 1NK, SM7YA, T12AV, 2LR, VP9R, VK3BZ, 3KN, 3LA, 3ZZ, XF1BT, 2FC, 2HD.

By R. F. Shamleffer, 1404 E. 124 No. 4, Cleveland, Ohio.

20 meter phone: G2PU-5, 5NI-9, 6IA-8, 6GF-8, YV5AE-9, 5AGF-9, SUICH-5, HK1EP-7, 4AG-5, OA4N-4, EI2L-9, LU7BK-5, EA9AH-8, VO6JO-9, 6D-6.

By Sidney G. Millen, 40 Wayland Street, Boston, Mass.

10 meter phone: G2HX-9, 5IO-6, 5GO-7, 5SA-6, 6DH-5, 6LC-7, 6LK-8, 6BL-6, 6RW-8, 6AG-8, 6WH-5, 8SA-8, GW2UL-7, GM6RG-9, F8K1-8, 8OD-7, 8WK-6, 8E12L-8, K5AT-8, VO3X-8, CN8AV-7, VP6YV-8.

By Albert Augustine, 7929 Eastwick Avenue, Philadelphia, Pa.

10 meter c.w.: EI5F-7, 6G-7, F3KH-8, SRR-8, SRS-7, 8TO-8, G2MF-7, 2XC-7, 2PL-7, 5I1-7, 5VB-7, 5BI-7, 5VU-7, 5OY-7, 5KM-8, 6NF-7, 6YL-7, 8SB-6, GM6RV-7, HH8L-6, HK4EA-9, HR4AF-8, OK1CX-6, 1FF-7, 2MV-7, 3VA-8, PAOAZ-7, ZS1AH-7.

10 meter phone: EI9I-7, G2IT-7, 5CY-7, 5BM-7, 5IQ-7, 5SA-7, 5ML-9, 6DH-7, 6YR-7, 6RW-8, 8SA-7, GM6RG-9, GW2UL-8, HK1JD-7, K6QE-8, LU9BV-8, ZT2G-6, 6AK-7, ZS6AJ-6.

20 meter c.w.: CN8AH-7, CX1BK-8, 1CG-8, 2AJ-5, DH8G-7, 4KMG-7, 4ONM-7, 4SNP-7, FANSA-8, FYSE-8, IIR-7, LA4P-7, VK2AD-8, 2AHA-8, 2DG-7, 2FF-7, 2HZ-8, 2NG-7, 2PX-7, 2OL-8, 2QE-7, 2TF-7, 2TI-8, 2XQ-6, 2XT-8, 2ZC-5, 3GD-4, 3GP-7, 3NG-8.

(Turn to page 447)

YOU CAN AFFORD THESE RIDER BOOKS



BUT

YOU CAN'T AFFORD TO BE WITHOUT THEM

VIBRATOR POWER SUPPLIES

by Garstang and Rider

It becomes increasingly important that service-men have the information on vibrator supply systems which is contained in this book. For vibrators are used in auto radio sets, 32-volt farm receivers, mobile P. A. systems, coin-operated music machines, etc. 280 pp. Profusely illustrated. \$3.00

NEW

AUTOMATIC FREQUENCY CONTROL SYSTEMS

by John Rider

With Automatic Frequency Control Circuits in most new higher-priced models, knowledge of "AFC" means money in your pocket! Learn the practical facts, from these easy-to-understand explanations. Get your copy today. Cash in on profitable "AFC" work. Hard covers. 144 pp. \$1.00.

JUST OUT

SERVICING SUPERHETERODYNES

Changes, changes, changes! That has been the history of the superheterodyne circuit. Make repairs quickly by analyzing the different parts of the circuit quickly. Rider shows you how in this revised edition which has 288 profusely illustrated pages. \$1.00

REVISED

THE CATHODE-RAY TUBE AT WORK

Written especially so you can understand the subject. With introduction of new, cheaper Cathode-Ray Tubes, this book is even more indispensable for its complete practical information on Oscillographs, etc. 336 pp. 450 illustrations. \$2.50

POPULAR

HOUR A DAY

WITH RIDER BOOKS - 60¢ each

ON AUTOMATIC VOLUME CONTROL will speed up your AVC work. 96 pp. 65 illus. ON RESONANCE & ALIGNMENT. You need this! 96 pp. 48 illus. ON D.C. VOLTAGE DISTRIBUTION IN RADIO RECEIVERS. How d-c voltages are led to tube elements, etc. 96 pp. 69 illus. ON ALTERNATING CURRENTS IN RADIO RECEIVERS—with drawings and diagrams.

WRITE TODAY FOR THE COMPLETE LIST OF BOOKS BY THE PUBLISHERS OF RIDER MANUALS

JOHN F. RIDER, PUBLISHER 1440 Broadway, New York City

YOU NEED ALL 8 Rider MANUALS



**WHEN A CONDENSER OUTSELLS ALL OTHERS— That's News!**

**CORNELL-DUBILIER TYPE JR-508 IS NOW THE FASTEST SELLING ELECTROLYTIC**



**HERE ARE THE REASONS WHY:**

1. Higher peak voltage breakdown.
2. Extremely low power factor.
3. Negligible leakage characteristics.
4. Accurate, full rated capacity.
5. Small, compact and sturdy.
6. Unconditionally guaranteed against internal corrosion.
7. 27 years' experience behind the product.

MICA PAPER  
WET & DRY ELECTROLYTIC  
CYKANOL

**CORNELL-DUBILIER ELECTRIC CORPORATION**  
1018 Hamilton Blvd.  
So. Plainfield, New Jersey

### Antenna A. B. C.'s

(Continued from page 419)

large voltage and a small current (high impedance). The load would be more receptive to this high ratio if it had the same high impedance. The converse is true.

Since the center of a half-wave Hertz antenna is at low impedance we can efficiently load the wire if our source of r.f. energy also has a low impedance. In Figure 3 we see a coil of a few turns connected at the center of the radiator and coupled to the tank coil of a transmitter. We have here a step-down transformer. The high voltage and low current of T is transformed into a comparatively low voltage and high current in A, which therefore matches conditions at the center of the radiator. The two quarter-wave lengths act as one continuous half-wave wire, except for a slight increase in wavelength of the antenna due to the presence of the coil. In the case of a full-wave wire we find that the points of low impedance occur at points a quarter-wave from either end. The coil could therefore be placed at either of these points, and since in this instance we have a center of high impedance, the coil would trans-

fer little or no energy if connected at the center.

Figure 3 is not a very convenient arrangement. We wish the antenna to be placed away from other objects which might affect it, and the tank coil belongs in the station. To remedy this condition we can use the set-up of Figure 4. We can now separate the radiator from the coupling coil and use "feeders" to connect them. In this circuit, arrows indicate points of high current and its direction, while plus and minus signs indicate points of high voltage and its polarity. Conditions on the radiator are the same as if we had no feeders. Electrons traveling to the right come down the feeder but just as many are coming up the other feeder and along the radiator to the right. Impedances are matched both at the station and at the antenna and we can expect efficient loading of the transmitter.

The variable condensers are used to counteract the effect of the coil in the circuit so that the natural wave-length is neither increased nor decreased. By using one in each feeder balance is maintained. This question of balance of the two feeders is very important. By following the arrows we can see that (assum-

*(Continued on next page)*

# TODAY'S BIGGEST VALUE IN Precision RADIO TESTERS

Precision built throughout, Readrite-Ranger Radio Testers need no apology from the highest class servicing shops. In fact you will find them using these rugged testers on calls because they have been particularly designed to withstand rough field work. Ask your jobber to show you today's biggest values in precision radio testers.

**Readrite**  
TESTERS **RANGER** METERS  
Combination  
Volt-Ohm-Milliammeter  
and Free Point Tester,  
Only \$28.35

The Readrite-Ranger Model 640 Free Point Tester has eight automatic switch type and ten single action jacks. Five sockets will handle any type radio tube. Model 740 Volt-Ohm-Milliammeter has 3" Square Triplett Precision Instrument. Scale readings: 10-50-250-500-1000 AC and DC Volts at 1000 Ohms per Volt (DC Accuracy 2%; AC 5%); 1-10-50-250 DC M.A.; 0-300 Low Ohms; High Ohms to 250,000 at 1½ Volts. (Rheostat adjustment for 13½ Volts for Ohms readings to 2½ Megohms. Batteries may be added permitting such readings in 250,000 Ohms steps.) Low Ohms to ½ Ohm with 25 Ohms in center of scale. Backup circuit used. Current draw is only 1 M.A. Batteries, accessories and instructions included.

*Bill - This is the Volt Ohm Milliammeter I spoke to you about. It's a honey.*

JAMES SMITH  
RADIO SERVICE INC.  
2024 MAIN STREET  
CITY  
PHONE  
RAD

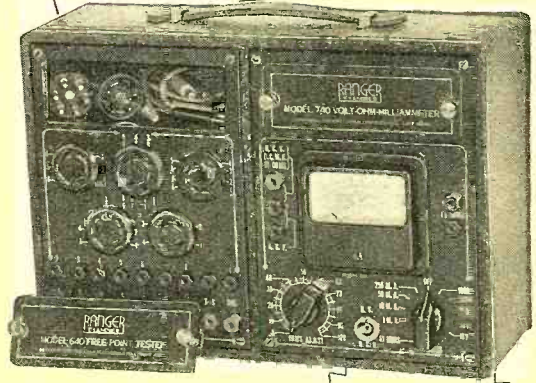

**NO EXTRA CASES TO BUY**  
Also Available As Single Testers

**PRECISION BUILT ONLY \$28.35**

**READRITE METER WORKS**  
115 College Ave., Bluffton, Ohio

Please send me more information on Model 640-740;  
 Model 640;  Model 740; I am also interested in.....

Name.....  
Address.....  
City..... State.....



ing the feeders of equal length) the currents in them are everywhere out of phase. The magnetic field of one will then be out of phase and will cancel that of the other so that no radiation can take place from them. The feeders must not be separated more than about 10 inches and must be fastened so that they do not swing. Another consideration is as we see from the plus and minus signs the necessity of good insulation. At these signs voltage is high and serious losses will take place unless the insulation is good.

The dotted lines in Figure 4 show that the feeders can also be a full wave-length. Every time we add a half-wave we come back again to a point of low impedance and can insert our coupling coil. The feeders then can be any multiple of a half wave-length. By placing r.f. ammeters at points of high current (as X and Y) we can determine if our feeders are balanced and therefore non-radiating. Variation of the condensers will bring about balance if the system is operating properly. The system just described is a current-fed feeder arrangement since it feeds the antenna at a current loop.

### Zeppelin Antenna

Figure 5 illustrates an antenna which is fed at a voltage loop. This is commonly known as the "Zepp". According to the diagram we see that we need feeders of a quarter wave-length each. A voltage loop will appear at the ends of the feeders and will match the impedance at the radiator end. In other ways it can be considered similar to the balanced arrangement previously considered. The theory is the same if we consider the "Zepp" a full-wave antenna with part folded over onto itself so that only half is radiating. Similarly, we can consider Figure 4 to be a one and one-half wave antenna with part folded. The dotted lines show that we can add any number of half-wave lengths to the feeders and come back to a current loop at the coupling coil. The feeders will have an odd number of quarter-waves standing in this voltage-fed type as against an even number for the current-fed feeders.

### Harmonic Operation

In the above systems we find that changes must be made in order to operate at harmonics. In Figure 4, for example, we will have voltage loops at the center for all even harmonics and cannot have a low impedance feeder connected to it. It would work, however, on odd harmonics in which case current loops would appear at the center. In Figure 5 we will always have a voltage loop at the end of the radiator, but

on further inspection we see that on even harmonics a voltage loop appears on the low impedance coupling coil and cannot be matched as before. It can be used, though, on all odd harmonics when we get back to a current loop at the coil.

A simple voltage-fed antenna system which can be used on all harmonics is shown in Figure 6. This is a variation of the "Zepp" feeder system. The entire length of wire up

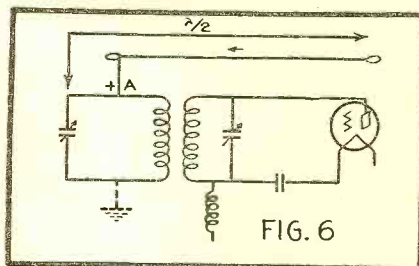

to the point A on the tuned circuit is the antenna and will radiate. It may be considered a parallel-tuned "Zepp" without the second feeder wire. Among the disadvantages of this antenna are the following: A high voltage point is brought into the station which may affect receivers, neutralization and produce losses if the insulation is poor. Also because of the single feeder wire, radiation will take place from the entire wire. However, its great advantage is that it will function at all harmonics since the point A will always have a voltage loop standing on it. Also, by means of a ground connection we can convert the system into a Marconi aerial which can be used on half the fundamental frequency.

### To Protect John Q. Public

New York, N. Y.—Observers in New York and other major cities report that misbranded inferior radio receivers, tubes and other equipment have virtually disappeared from shop windows following a clean-up instituted in New York City and Newark by authorities acting in the public interest. Violations of the Penal Laws of the State of New York brought twelve convictions and sentences. The defendants were convicted of selling spurious sets bearing the well-known trade-marks "Victor", "Brunswick" and "Edison."

### Plan Facsimile Test Broadcasts

Washington, D. C.—A recent F.C.C. bulletin disclosed that six applications have been received in the past three months for permits to establish facsimile experimental broadcasting stations. Permits were granted station WGH, Hampton Roads Broadcasting Corp., Newport News, Virginia; and station WHO, Central Broadcasting Company, Des Moines, Iowa.

Learn  
RADIO  
in  
12 WEEKS

BY ACTUAL SHOP WORK  
ON REAL EQUIPMENT

### SEND TODAY FOR DETAILS OF MY "PAY AFTER GRADUATION" PLAN

Prepare now for big opportunities in the world's most fascinating profession. Get a training in the Coyne Shops in a practical way that will give you your start in this great field . . . I offer you the opportunity to finance your training. Send now for details of my "Pay After Graduation" Plan and Big FREE illustrated book with all the facts about Coyne training. Mail Coupon today for details.

### REAL OPPORTUNITIES For the Radio Trained Man

Prepare for a job as Designer, Inspector and Tester—as Radio Salesman and in Service and Installation—as Operator or Manager of a Broadcasting Station—as Wireless Operator on a Ship or Airplane—as a Talking Picture or Sound Technician—HUNDREDS OF Opportunities for fascinating, WELL PAID JOBS!

### 12 WEEKS' SHOP TRAINING No Experience or Advanced Education Needed

We don't teach by book study. You get your training at Coyne in Chicago by ACTUAL WORK on a great outlay of Radio, Broadcasting, Television, Talking Picture and Code equipment. And because we cut out useless theory, you get a practical training in 12 weeks. That's why you don't need advanced education or previous experience.

### TALKING PICTURES—TELEVISION

Talking Pictures and address systems offer great opportunities to trained men. Television is the great new branch of Radio now developing very rapidly. Be ready for your chance in Television. At Coyne you are trained on real Talking Picture and Television equipment.

### ELECTRIC REFRIGERATION AND AIR CONDITIONING Included at NO EXTRA COST

So our graduates may have an all around training which increases their earning capacity, we are including for a short time a training in Electric Refrigeration and Air Conditioning. Here is your chance to get a practical training in this great new field at no extra cost.

### MANY EARN WHILE LEARNING Employment Help After Graduation

When you enroll at Coyne you get a Life Scholarship. You get Free Employment Service for Life after Graduation. If you need part time work to help pay living expenses we will help you get it. Coyne is 39 years old. Coyne training is tested—you can find out everything about our course and "Pay After Graduation" Plan. Just Mail Coupon for My Big FREE RADIO BOOK.



H. C. Lewis

### SEND NOW FOR FULL DETAILS!

H. C. LEWIS, President,  
Coyne Electrical & Radio School,  
500 S. Paulina St., Dept. 18-3K, Chicago, Ill.

Dear Mr. Lewis:—Send me your big Free Radio Book and all details of your Special Tuition Offer—and about your "Pay After Graduation" Plan.

Name.....

Address.....

City.....State.....



# BETTER BALANCED CIRCUITS

with



Adjustable Coupling

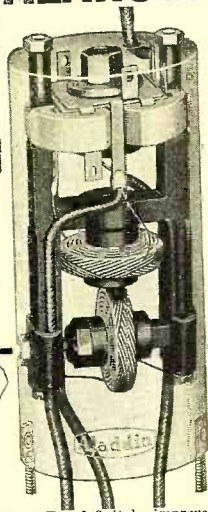

Type "A" Aladdin Polyiron I-F's definitely improve receiver performance! They are made of POLY-IRON, an amazing material, which gives a remarkably higher degree of Selectivity and Sensitivity. They have an exterior ADJUSTABLE COUPLING which enables you to produce the critical coupling necessary for I-F circuits. . . . In just one second, you can broaden the curve and increase the sensitivity . . . or you can increase the selectivity and at the same time reduce the gain. Try Aladdin Polyiron I-F's . . . you'll be astounded by the improvement. Write now for FREE Technical Data, Curves and complete Catalog. No obligation.

**ALADDIN RADIO INDUSTRIES, INC.**  
466n W. Superior Street, Chicago, Ill.

Licensee of Johnson Laboratories, Inc.  
These devices manufactured under one or more of the following U. S. Letters Patents 1,887,880 1,940,528 1,978,858 1,978,859 1,978,860 1,982,689 1,982,690 1,987,455 2,008,500 2,082,590 2,005,305 2,018,626 2,028,531 2,032,580 2,032,521 2,035,423 2,061,012 2,050,505 2,032,557 2,082,580 2,032,512. Other patents pending.



Send for your copy TODAY

## Do You Like RADIO

### TELEVISION, SOUND & ELECTRICITY

You men who want to know the true facts about employment opportunities and requirements in radio and related industries should have National's new book—40 pages of information and illustrations.

**NATIONAL SCHOOLS**

**NATIONAL SCHOOLS**  
Dept. RN-1 4000 So. Figueroa Street, Los Angeles, Calif.  
Please Send Free Book

NAME \_\_\_\_\_ AGE \_\_\_\_\_  
ADDRESS \_\_\_\_\_  
CITY \_\_\_\_\_ STATE \_\_\_\_\_

## PRICES REDUCED

on two Brush microphones—BR2S and B-1. If your jobber can't supply you, write us.

**THE BRUSH DEVELOPMENT CO.**  
3311 PERKINS AVE., CLEVELAND, OHIO

### RADIO IN IT S ENTIRETY!

"B.A." serves the trade with every need in radio—complete 160-page catalog of nationally known radio receivers, public address, parts, supplies and equipment. Orders shipped same day received.

COMPLETE CATALOG AVAILABLE

**BURSTEIN-APPLEBEE CO.** 1012-14 MCGEE ST. KANSAS CITY, MO.

## The DX Corner (Short Waves)

(Continued from page 418)

### North America

**CRCX**, Toronto, Ontario, Canada, 5125 kc.-6090 kc., heard 7 a.m., relays CRCT (Alfred), week days only 7:45 a.m.-5 p.m. (Meehan). Address: Canadian Broadcasting Corp., Toronto.

**CFRF**, Toronto, Ontario, Canada, 6070 kc., heard 10:30 p.m. (Harley).

**CJCX**, Sydney, Nova Scotia, Canada, 6010 kc., reports are requested (D'Orsay).

**CFRX**, Toronto, Ontario, Canada, 6070 kc., daily 7-12 p.m. (Unger). Address: 37 Floor St., West Toronto.

**CJRO**, Winnipeg, Canada, 6150 kc., heard 4-10 p.m. (Lindner).

**XEBR**, Hermosillo, Mexico, 11,820 kc., heard 10-12 p.m. (Fleming).

**XEBT**, Mexico, D. F., Mexico, 6000 kc., daily from 5 p.m. (Westman, Diez), heard 8 p.m. (Coover).

**XEWW**, Mexico, D. F., Mexico, 9485 kc., heard 9-12 p.m., 15,160 kc., 6-9 p.m., relays XEW (Alfred), heard 2-12 p.m. (Welper, Wollenschlager, Pierce), 15,140 kc. (Diez), daily 7-12 p.m. (Dressler, Shamleffer). Slogan: "The Voice of Latin America." Address: P. O. Box 2516.

**XEFT**, Vera Cruz, Mexico, 9550 kc., heard 10-12 p.m., chimes, cuckoo call, and bugle used (Welper, Diez).

**W2XAF**, Schenectady, N. Y., 9530 kc., daily 4-12 p.m. (Welper, Patrick, Harley, Lander, Unger, Mesarana, Fleming).

**W1XAL**, Boston, Mass., 11,790 kc., 6040 kc. (Harley), 15,250 kc., experimental freq. (Welper, Milten), daily except Saturday and Sunday (11,790 kc.), 4:45-6:30 p.m. (6040 kc.), 7-9 p.m. Saturday (11,790 kc), 1:45-6:30 p.m., Sunday 5-7 p.m. (Shamleffer, Fleming, Westman, Allison).

**W9XF**, Chicago, Ill., 6100 kc., heard 10:30-11 a.m. (Harley, McCue).

**W8XAL**, Cincinnati, Ohio, 6060 kc., heard 11:05 p.m. (Harley, Mesarana).

**W2XAD**, Schenectady, N. Y., 15,330 kc., daily 10 a.m.-8 p.m. (Welper); Wednesday 7-10 p.m., Sunday 7-9:25 p.m. (Unger, Shamleffer, Beard, Diez); 15,290 kc., daily except Saturday, 2-9 p.m., Saturday 11 a.m.-9 p.m. (Fleming).



**SOUTH AFRICAN OBSERVER**  
This is Allan B. E. Goetsch, observer for Idutywa, South Africa. His receiver is a 27-tube Scott and he can record received programs.

**W2XE**, New York, N. Y., 15,270 kc., daily except Sunday 2-5 p.m., Sunday 4-5 p.m., 11,830 kc., daily except Sunday 5:30-11 p.m., Sunday 6-11 p.m. (Welper, Fleming); 17,870 kc. (Diez); also 6120 kc., 17,760 kc., and 21,520 kc. (from veri) (Margorie).

**W3XAL**, Bound Brook, N. J., 17,780 kc., heard 8 a.m.-8 p.m. (Welper, Harley, Chadwick, Chokan, Van Os, Mesarana, Diez); 6100 kc., (Fleming).

**W3XAU**, Philadelphia, Pa., 9590 kc., daily except Sunday and Wednesday 11 a.m.-7 p.m. (Welper, Patrick); 6060 kc., daily 7-11 p.m. (Fleming, McCue). Address: W. O. A. U. Building, 1622 Chestnut St.

**W8XK**, Pittsburgh, Pa., 11,810 kc., daily 9 a.m.-7 p.m. (Welper, Patrick); 15,210 kc. and 11,870 kc. (Fleming); 6140 kc. (Oglesby, Diez, Allison, Shamleffer).

**W1XK**, Boston, Mass., 9570 kc., heard daily 7 a.m.-1 a.m. (Welper, Patrick).

**W9XJL**, Superior, Wis., 26,100 kc., desire reports (Harris, Maxwell).

**KKQ**, Bolinas, Calif., 11,950 kc., heard 11:30 p.m. (Welper), heard Wednesday 9 p.m. (Myers), heard 8-9 p.m. (Kentzel)

**W9XAA**, Chicago, Ill., 11,750 kc. (Diez), 6080 kc., daily 6-11 p.m. (Fleming), 11,830 kc. (Atherton).

### Central America

**TIPG**, San Jose, Costa Rica, 6410 kc., heard 10 p.m. (Shamleffer), 11,710 kc. (Diez). Slogan: "La Voz de la Victor."

**TIEP**, San Jose, Costa Rica, 6696 kc. (Diez), heard 7 p.m. (Coover).

**TILS**, San Jose, Costa Rica, 5800 kc., daily 7-11:50 p.m. (Fleming).

**ZIK2**, Belize, British Honduras, 10,560 kc., heard irregularly 7:15-8 p.m. (Fleming).

**TG2X**, Guatemala City, Guatemala, 5940 kc., daily 9-12 p.m. (Fleming).

**YSM**, San Salvador, El Salvador



dor, 11,710 kc., Sunday 9-9:30 p.m. (from veri), (Alfred, Partner, Diez, Birnie, Knight). Slogan: "Radio Nacionales." Address: Telegrafas, Telefonas Y Radio Nacionales, Direccion General, El Salvador.

YSD, San Salvador, El Salvador, 7890 kc., daily 9-10:30 p.m. (Alfred, Gallagher, Eder). Address same as YSM.

YNAM, Managua, Nicaragua, 7200 kc., daily 9-11 p.m. (from ann.) (Fleming).

HP5A, Panama City, Panama, 11,700 kc., heard 6-10 p.m. (Welper) (from veri), (Alfred, Millen, Unger, Magnuson, Partner, Diez, Dressler, Coover), daily 5-10 p.m. (Fleming, Shamleffer). Slogan: "Radio Teatro Estrella de Panama."

HP5L, David, Panama, 11,740 kc., heard 4-7 p.m. (Welper).

HP5J, Panama City, Panama, 9690 kc. (Unger, Diez), 9590 kc., daily 5-10:10 p.m. (Fleming). Slogan: "The Voice of Panama."

**South America**

OAX5A, Ica, Peru, 9630 kc., irregularly 7-9 p.m. (Alfred). Slogan: "Radio Universal de Ica."

OAX4T, Lima, Peru, 9630 kc., daily 6 p.m.-1:30 a.m. (Margrie).

OAX4Z, Lima, Peru, 6082 kc.,

(Continued on next page)

daily 5-11 p.m. (Margrie). Slogan: "Radio National." Address: Avenida, Abancay 915.

HJ7ABD, Bucaramanga, Colombia, 9630 kc. (Meehan); desires reports (Shamleffer); daily 10-12 a.m. and 4-10 p.m. (Geneve, Markuson, Atherton, Betances, Kentzel); reports requested (Gallagher, Magnuson). Slogan: "Radio Bucaramanga."

HJ2ABD, Bucaramanga, Colombia, 9630 kc., 7-10:30 p.m. (Lindner, Fleming). Slogan: "Radio Bucaramanga."

HJ4ABH, Armenia, Colombia, 9520 kc., 9:30-10:20 p.m. (Welper, Wollenschlager); daily 6-10 p.m. (Dressler, Shamleffer).

HJ3ABD, Bogota, Colombia, 4841 kc., daily 7-10 p.m. (from veri) (Alfred Nigh). Slogan: "Colombia Broadcasting."

YV1RL, Maracaibo, Venezuela, 5930 kc., weekdays 11 a.m.-1 p.m., 4:30-9:30, Sunday 8:30 a.m.-2:30 p.m. (from announcement) (Markuson).

YV2RB, San Cristobal, Venezuela, 5720 kc., daily 6-11:30 p.m. (Cindel).

YV5RC, Caracas, Venezuela, 5800 kc., 6 p.m. (Coover); daily 6-10:30 p.m. (Fleming, Shamleffer); relays YV5RA (Markuson).



★ "THERE is nothing on the market that can compare with this new receiver," says Charles W. Eggenweiler, Los Angeles, California. Mr. Eggenweiler adds, "The new 'Super-Pro' is very quiet and selective. The splendid Hammarlund workmanship and engineering has made it the last word in receivers. On 10 meters, it beats anything I have ever tried."

Countless others are likewise applauding this distinctive receiver that has such outstanding features as—two stages of R.F. on all bands, including the 20-40 mc. band providing an average sensitivity of 0.8 microvolt (30% modulated) with a signal to noise ratio of 6 to 1! The image rejection ratio is so high as to provide complete freedom from "two-spot" tuning except in exceedingly rare instances. For instance, at 28 mc. the ratio is 150 to 1; at 7 mc.—10,000 to 1.

Other features are—four air tuned I.F.; electrostatically shielded input; electrical band spread; high fidelity; variable band width (3 to 16 kc.) panel control; direct tuning; visible tuning meter; stand-by switch; relay terminal strip; variable crystal filter, etc. Crystal or standard models are available for table or rack mounting. New console model with high fidelity sound chamber and standard "Super-Pro" now available too. Tuning ranges for 7½ to 240, 15 to 560, or 15 to 2000 meters. Special "Super-Pro" bulletin contains further data, interesting curves, and illustrations. Mail coupon for your free copy.

**3 New American Tubes**

New York, N. Y.—RCA has announced three new tubes to be designated 1608, 1609 and 1610 which are now available through transmitting tube distributors. The 1608 is a transmitting triode suitable for Class B and Class C amplification and as an oscillator. It may be operated at maximum ratings up to 45 mc., up to 70 mc. with plate voltage and plate input of 75 percent of maximum ratings. The maximum plate input per tube is 40 watts and maximum plate dissipation 20 watts in Class C telegraph service. The filament requires 2.5 volts at 2.5 amperes while the maximum plate voltage is 425 volts. A pair of these tubes will deliver 50 watts as Class B audio amplifiers, 10 watts as Class B "linear", 18 watts as plate-modulated Class C amplifier and 27 watts as a Class C amplifier for c.w. or as an oscillator.

Type 1609 is a pentode voltage amplifier of low microphone design for pre-amplifiers. It is a direct heated tube requiring a filament supply of 1.1 volts at 0.25 amperes. Maximum plate supply is 135 volts. The amplification factor is 300, transconductance 725 micromhos and plate resistance 0.4 megohms. It does not have a grid cap, all connections coming out at the base. The socket layout is the same as for type 33.

Type 1610 is a direct-heated pentode intended for use as crystal oscillator. It may be operated at maximum ratings up to 20 megacycles, at 75 percent of maximum ratings up to 110 megacycles. The maximum plate dissipation for Class C service is 6 watts. The filament is rated at 2.5 volts, 1.75 amperes. Maximum plate potential is 400 volts; screen, 200 volts. The tube delivers approximately 5 watts

output. The socket connections are the same as for type 47.

**More Phone Systems**

Camden, N. J.—The RCA Manufacturing Company is placing on the market, two RCA-Victor inter-office communication phone systems, one of which is of the "wired-wireless" type.

**6AC5G**

Pawtucket, R. I.—A new output tube, the 6AC5G, has been announced by Triad. This tube is intended to be used in connection with a 76 driver and employing "dynamic coupling," that is, the load of the 76 tube is to be placed in the cathode circuit and this cathode connects to the grid of the 6AC5G. A single ¼ megohm resistor is the only other part required in the circuit of both tubes, it is connected between grid and cathode of the power tube. The tube requires 6.3 volts for the filament at 0.4 ma. With a plate supply of 250 volts, the rated power output is 3.7 watts and the total harmonic distortion ten percent.

**6F8G**

New York, N. Y.—A new double triode tube, the 6F8G, has recently been announced by Raytheon. It is a 6.3 volt filament tube requiring 0.6 ampere filament current. The two triode sections have independent cathodes which greatly increases the possibilities of its use. Electrically, the characteristics of each triode section is similar to the 6J5G. With a plate potential of 250 volts, the recommended grid bias is 8 volts and the plate current 9 ma. The amplification factor is 20, the mutual conductance 2600 micromhos and the plate resistance 7700 ohms.



HAMMARLUND MFG. CO., INC.  
424-438 W. 33 St., N. Y. C.

Please mail me "Super-Pro" bulletin.

Please mail new "38" catalog.

Name .....

Address .....

City..... State.....RN-1-38



Canadian Office: 41 West Ave. N. Hamilton, Ontario







## 600 V. ELECTROLYTICS

- Your choice of either metal-can or cardboard-case general-utility electrolytics. Compact. Fit anywhere. Inexpensive.
- 600 v. D.C. working. Provide extra safety margin. Use them to meet high surge voltages.
- Metal-can type inverted-screw mounting. Cardboard type has Adjustable universal mounting flanges of metal.

**Ask** your jobber or write us direct for latest catalog covering the widest choice of essential components.

**AEROVOX**  
CORPORATION  
70 Washington St. : : Brooklyn, N. Y.  
IN CANADA: AEROVOX CANADA, Limited, Hamilton, Ont.

**NO FLAWS—  
NO FLUKES—  
NO FAILURES—**

**BUD**

A BUD relay rack is a "thing of beauty and a joy forever".  
A thing of beauty because it has been styled to look just right. A joy forever because of its inherent ruggedness. All steel—free of flaws. Sturdy enough to eliminate vibration.  
Relay racks are just one of hundreds of dependable products in the famous BUD line. Write for FREE descriptive catalog, No. N-138.  
**BUD SELLS FOR LESS—AT ALL BUD AUTHORIZED JOBBERS.**

**BUD RADIO, INC.**  
5205 CEDAR AVE. CLEVELAND, O.

### CODE—TAPES FOR EVERY NEED



You can easily learn or improve your Radio or Morse Code—typical messages are sent you by the INSTRUCTOGRAPH, at any speed. Senior model with 10 tapes and Book of Instructions—\$20.25 (Rented at low cost.) Junior model with 5 tapes and Book of Instructions—\$12.00 (Not rented). Complete oscillator equipment, less battery, \$6.50. Send for full information today.

INSTRUCTOGRAPH CO., Dept. NR-1, 912 Lak-side Pl., Chicago, Ill. Representatives for Canada: Radio College of Canada, 865 Bay St., Toronto.

Buy on Cash or Terms—

HALLICRAFTER and R.M.E. SHORT WAVE RECEIVERS—SPEED-X and VIBROPLEXES.

### 12" MAGNAVOX

Speakers. All New, in original cartons. Curvilinear cone, 900 ohm field, output to match Single Pentode (42-6F6, etc.) Shipping wt. 8 lbs. **EACH \$2.89**

Write for our New FREE 38 Page Catalog

ARROW SALES COMPANY

27 S. Jefferson St.

Chicago, Ill.

**CXA8**, Montevideo, Uruguay, 9640 kc., daily 8-11 p.m. (Gallagher, Shamleffer). Address: Belgrano 1841, Buenos Aires.

**HC2JSB**, Guayaquil, Ecuador, 7854 kc., daily 9 a.m., 2 p.m. and 4-11 p.m. (Markuson). Address: P. O. Box No. 805.

**LRU**, Buenos Aires, Argentina, 15,290 kc. (Diez); daily 7-9 p.m. (Markuson).

**LR3**, Buenos Aires, Argentina, 9645 kc., daily 12-11 p.m. (Westman). Slogan: "Radio El Grando."

#### West Indies

**HIT**, Trujillo City, Dominican Republic, 6630 kc., daily 5:40-8:40 p.m., Saturday 10:40 p.m.-12:40 a.m. (Cindel).

**HIL**, Trujillo City, Dominican Republic, 6500 kc., daily 4:40-5:40 p.m. (Betances); daily until 9 p.m. (Markuson). Slogan: "Emisara Diario Nacional."

**HIIX**, Trujillo City, Dominican Republic, 5980 kc., 8:20-9:30 p.m. (Harley); 6340 kc., relays HIX (Patrick).

**HI2X**, Trujillo City, Dominican Republic, 11,960 kc., relays HIX, daily 8:30-8:45 p.m. (Patrick). Signed Wednesday 9:50 p.m. (Myers).

**HI1A**, Santiago, Dominican Republic, daily 3:10-4:40 p.m. (Betances).

**HH3W**, Port-au-Prince, Haiti, 9650 kc., 7-8 p.m. (Nigh).

**COKG**, Santiago, Cuba, 6200 kc., 5-9 p.m. and 10-11 p.m. and 12-2 a.m. (Cindel).

**COCE**, Havana, Cuba, 9830 kc., daily 4-11 p.m. (Westman).

**COCW**, Havana, Cuba, 6330 kc., 7-11 p.m., relays CMW (Alfred, Millen, True, Scala, Betances, Atherton). Slogan: "La Voz des Antillas." Address: P. O. Box No. 130—Director Tecnico, Peso de Marti.

**COBX**, Havana, Cuba, 9150 kc., daily until 11:30 p.m. (Markuson, Betances); 9180 kc. (Markuson, Eder). Slogan: "Of Radios Alvarez."

**COCO**, Havana, Cuba, 12,000 kc., relays CMCF, 10:15-12 midnight, 6010 kc. (Welper, Diez, Mesorana, Scala). Address: P. O. Box No. 98.

**COJK**, Camaguey, Cuba, 8665 kc., relays CMJK, weekdays, 7:45-10 p.m. (Welper, Alfred, Harley); 8720 kc. (Diez); daily 6-10:30 p.m. (Dressler, Fleming, Shamleffer). Slogan: "Radio Zenith." Address: Finlay No. 3 Altos.

**COCD**, Vedado, Cuba, 6130 kc., daily 11 a.m.-11:30 p.m., Sunday 11 a.m.-9 p.m. (Scala). Slogan:

"La Voz Del Aire."

### Readers Who Are Awarded "Honorable Mention" for Their Work in Connection with This Month's Short-Wave Report

**MORTON MEEHAN**, Robert Pinkerton, Ralph C. Sullivan, Herman Ruppert, P. J. Van Os, S. F. Gallagher, Harry Kentzel, R. C. Messer, William T. Murray, Erroll R. Birnie, H. Westman, Charles F. Myers, P. L. Stiles, Raymond Hernday, John Lindeberg, Sydney Millen, Fred Atherton, Bill Lander, Charles Ford, E. M. de Cottignies, H. Wickens, Sherwood Espenschild, Frank Sakely, Sr., C. W. Chadwick, Thomas Fallon, Jr., George M. Fleming, Mil. M. Pavlovitch, Donald G. McKenzie, Jose E. Mesorana, L. G. Pairman, Heinz Pankow, Clarence M. Meyers, William D. Adkins, Bob Carroll, Kenneth Dressler, Anton J. Cindel, Manuel Betances, M. J. Markuson, Edward J. Margrie, Leslie Mott, Frank Sekach, Robert McCue, J. Wendell Partner, Charles Pierce, Harold E. Lindner, A. M. Rheiner, Gilbert L. Harris, G. H. Allison, Oscar Westman, Leslie Maxwell, Vincent M. Poll, H. B. Sargent, Gustave A. Magnuson, R. F. Shamleffer, N. C. Smith, Carl & Anne Eder, Eric Gertenbach, Peyton Black, Elmer Duncan, Arthur B. Coover, Renato Brossa, C. R. Wilson, Luis Diez, William Beard, Enrico Scala, Jr., A. W. Brummund, H. Mallet-Veale, Warren D'Orsay, William W. Oglesby, Jr., Burnell Unger, James Nigh, Jr., E. Geneve, G. H. Russell, William Dean Noyes Eric W. Watson, D. Summers-Smith, P. L. Patrick, D. A. Harley, Jr., Troy Welper, Fred W. Alfred.

### 17 Years of Broadcasting

(Continued from page 393)

strong enough to support the weight of the steel plus about 20 tons additional load added by the pull of the guys. The main insulator, though only three feet high, has been tested to withstand loads of more than 100 tons. About half-way up the spire, three smaller sectionalizing insulators have been inserted to break the antenna, electrically, at a height of 336 feet. Insulators are also inserted in the guy wires to eliminate radiations from this source or the conducting of current to the ground.

Completely insulated from the ground, the steel spire becomes charged with static during storms, then crackles and sparks continuously. Such electrical phenomena have no effect on its broadcasting efficiency. To improve the conductivity of the ground around the antenna 50 miles of copper wire have been buried a foot under the surface, radiating out, one degree apart, for 700 feet. The vast efficient ground system so formed aids in reducing the effect of skywave emissions.

An eight-wire radio-frequency line sends the output of the transmitting station to a tuning house near the base of the antenna. From this point



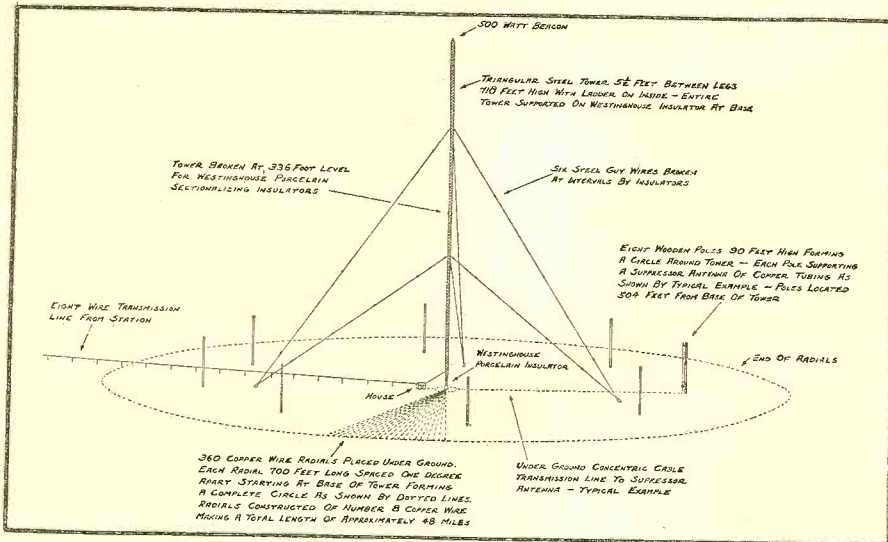

four power lines run up inside the spire carrying radio frequency and current for a brilliant aviation beacon at the tip as well as four riding lights installed along its sides.

Last year (October 30, 1937) when erected to a height of 644 feet, the original vertical antenna buckled and fell. Since that time extensive testing has been given all the new parts for the new spire to ascertain their ability to support the unusual strains and loads induced. Guy wire attachments are set in concrete piers 400 feet from the base of the antenna. Two sizes of wires are used, that supporting the top section being one-inch cable pre-stretched and tested to 52,000 pounds; the lower guys of seven-eighths inch cable tested to 41,000 pounds. The top guys connect to the tower at the 526-foot level and the lower guys at 270 feet. Forged steel turnbuckles, used to tauten the wires, are strong enough to withstand pressures exerted by 100,000-pound pulls.

The bottom steel antenna section is shaped as an inverted triangle with a squared-off tip. This tip, less than eighteen inches wide, forms the peg on which the 718-foot structure sits and permits it to sway slightly under stress. A concrete pier, 10 feet wide, deep in the ground, provides the supporting foundation.

### Free Code Instruction

New York, N. Y.—Under the auspices of the New York City Board of Education free code instruction is offered to prospective amateur and commercial operators. The course is conducted Monday to Thursday evenings, 7:30 to 9:30 p. m. at the Harlem Evening Trade School, 138th Street and Fifth Avenue, New York City.

550 Kc.

Washington, D. C.—The F.C.C. has announced a new policy in regard to licensing

The welded steel sections of the antenna are built of straight round bars with smaller round spacing bars placed at angles forming V's. Partially stream-lined by these round members, loads caused by wind pressure are minimized.

Engineers will operate the sky-scraping radiator at three-quarters of a wave-length, thus establishing a new record for efficiency as all prior vertical types have been limited to a maximum electrical length of five-eighths of a wave-length. Transmitting efficiency increases directly as the electrical length of the antenna is extended.

Electrically, the antenna is split in the middle by its sectionalizing insulators to cause an even distribution of current. Normally, current reverses itself every half wavelength but by feeding different voltages to the upper and lower sections the current flows in the same direction throughout the length of the spire.

Though now the highest welded structure in the world—nothing is close to it in slim height—the antenna was erected in 72 working hours by a crew of nine men. Its top beacon and lightning rod would be level with the roof of the Radio City building in New York whence come many of the NBC network programs broadcast by KDKA.

broadcast stations on 550 kc. so as to avoid interference with naval communications. No station will be licensed for greater power than 1 kilowatt at night or 5 kilowatt in daytime on this frequency. Applications for new stations or increase in power in locations less than 300 miles from the coast must be accompanied by written approval of the Navy Department. No new station or increase in power or time will be granted in zones between 300 and 500 miles from the coast without approval of the Navy Department. The above mileages may be increased or decreased so as to insure that a signal strength of not more than 100 microvolts per meter will result at the nearest coast or point of naval communications activities.

# SAVE 52%

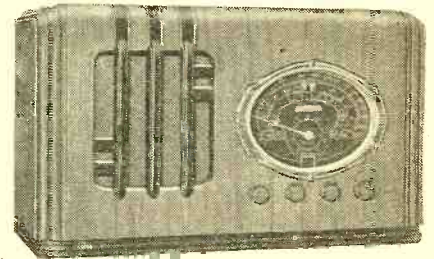

## ON 1938 DELUXE RADIOS!

Never before have such genuine radio values been offered to you at such a tremendous saving. New 1938 models at 52% DISCOUNT! Illustrated is 8 tube "World-Wide" . . . Powerful Superhet . . . 1 stage R.F. Ampl. on all bands . . . 16 to 560 Meters, 3 bands A.V.C. . . . Extreme Sensitivity . . . Ultra-Selectivity . . . AC or Battery Model. Other models from 5 to 14 tubes. Write for FREE complete descriptions, prices and 1938 Hetro Catalog. Buy direct! Save 52%!

FOREIGN DISTRIBUTORS—The extensive HETRO line, long manufactured for the Export Trade, offers real money-making opportunities. Write or CABLE for Territories still available.

HETRO ELECTRICAL INDUSTRIES, Inc.  
4611 Ravenswood Ave., Chicago, Ill., U. S. A.

Send me FREE complete descriptions on all NEW 1938 Deluxe Hetro Models. Also quote your DIRECT FROM THE FACTORY PRICES with savings of 52% and liberal 10 DAY FREE TRIAL OFFER in U. S. A.

Name.....

Address.....

# NEW 1938 HETRO RADIO

MANHEIM POCKET SLIDE RULE  
Polished stainless steel back frame, flexible scale slide, glass hairline runner, A B C D scales. Length closed 6". No celluloid—no wood. Non-shrinking. Accuracy guaranteed. In leather case with instruction booklet.

ONLY \$1.00  
Postage Paid  
Sevan Co.  
Dept. 18  
7 E. 42 St.  
New York City



# FOR THE RADIO SERVICE MAN, DEALER AND OWNER

The man who enrolls for an I.C.S. Radio Course learns radio thoroughly, completely, practically. When he earns his diploma he will KNOW radio. We are not content merely to teach the principles of radio, we want to show our students how to apply that training in practical, every-day, radio service work. We want them to make good, to make money, to be successful radio experts.

INTERNATIONAL CORRESPONDENCE SCHOOLS

Box 8280-T, Scranton, Penna.  
Explain fully about your course in the subject marked X:

- RADIO
- EXPERIMENTAL TELEVISION
- SOUND TECHNICIANS
- AVIATION SECTION OF RADIO OPERATING

Name..... Age.....

Address.....



**• Radiomen**  
**It Pays to Know**



**How You Can Make More Money And Enjoy a Real Future in Radio Step Ahead into a Better Job**

STOP thinking about those better-paying jobs in Radio and start training now! There's a reason why the good men have the good jobs. CREI home-study training is the answer. Let us show you what our courses have done for others. If you are already in Radio . . . If you are ambitious . . . If you will devote time for study . . . WE CAN DO THE SAME FOR YOU . . . Write us and we'll tell you all about it.

**You'll want to read our new booklet "A TESTED PLAN FOR A FUTURE IN PRACTICAL RADIO ENGINEERING"**

IT'S FREE! Write today for your copy of this interesting, illustrated booklet. Just off the press! You'll thank us many times after you read its 48 pages.

**CAPITOL RADIO ENGINEERING INSTITUTE**  
Dept. RN-1  
14th & Park Road—Washington, D. C.  
New York City—29 Broadway

**BOY! THIS MAKES RADIO REPAIRING A CINCH**

**RADIO KINK-AIDS**

ONLY \$1.95  
Complete with Metal Cabinet

Practical Repairs for 3,000 RECEIVERS  
Over 3,000 filed and indexed service kinks to repair those hard-to-fix home and auto radios. Just pull out the card corresponding to the name and model of the set you are repairing, and there you have listed the service troubles found in that radio and how to fix them.



FREE WRITE FOR BULLETIN RN-1 AND SAMPLE CARDS

**AKRAD PRODUCTS CO.**  
362 Wooster Ave. Akron, O.

Tear out this ad, write your Name and Address in the margin, mail \$1.95 and we will send outfit at once.

**Every Progressive Radio Man Needs the 1938 Radio Data Book**

Whether radio is your business or your hobby, you'll find the 1938 RADIO DATA BOOK packed full of useful information. There are constructional details for television, short-wave, high-fidelity and all-wave receivers—how-to-build data for a test oscillator, signal generator, tube voltmeter and oscilloscope—circuit diagrams on P. A. systems—valuable service hints—experimental data—amateur aids—constructional data on "ham" receivers and transmitters—receiving and transmitting tube charts—a world short-wave station list—and many other big features. Get your copy of this new book FREE by sending \$1. for a 5-month new or renewal subscription for RADIO NEWS. (Canada and Foreign \$1.25.)

Radio News, Dept. 331a,  
461 Eighth Ave., New York, N. Y.

**Set Tester**

(Continued from page 405)

plus 2.5 ohms) or 350 ohms. The sectional values in the 50-ohm shunt are calculated by multiplying the total "ring resistance" (350 ohms) by the full-scale current of the meter (0.001 ampere), dividing the result by each range value in turn from the common terminal and subtracting the sum of the preceding values from each newly determined value.

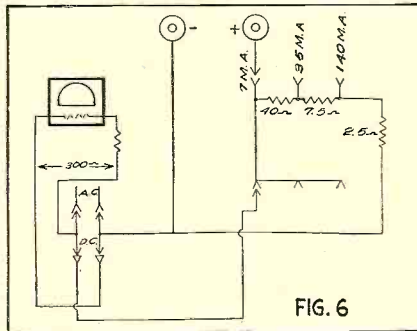

FIG. 6

By multiplying 350 by 0.001 ampere, we get a value of 0.35 into which each range, in turn, is divided. Dividing 0.14 (140 ma.) into 0.35 gives us a value of 2.5 ohms for our first resistor. Dividing 0.035 (35 ma.) into 0.35 gives us a value of 10 ohms from which we subtract 2.5 ohms, the value of the 140 ma. range resistor, leaving 7.5 ohms as the value for the second resistor. The third resistor is the difference between 10 ohms and 50 ohms or 40 ohms.

**Read Classified Advertising—It Pays**

Advertisements in this section sixteen cents a word for each insertion. Name and address must be included at the above rate. Cash should accompany all classified advertisements unless placed by an accredited advertising agency. No advertisements for less than 10 words accepted. Objectionable or misleading advertisements not accepted. Advertisements for these columns should reach us not later than 3rd of 2d month preceding issue.

TECK PUBLICATIONS, INC.  
461 Eighth Ave. New York, N. Y.

**Correspondence Courses**

USED Correspondence Courses and Educational Books sold or rented. Inexpensive. Money-back guarantee. Write for Free Catalog listing 4000 bargains. (Courses Bought.) Lee Mountain, Pisgah, Alabama.

**Detectives**

DETECTIVES—Make Secret Investigations. Write, George Wanger, 2640-R Broadway, New York.

**Patent Attorneys**

PATENTS. Instruction "How to Establish Your Rights" and form "Evidence of Conception" sent Free! Lancaster, Allwine & Rommel, 414 Bowen Building, Washington, D. C.

PATENTS—Advice and booklet free. Highest references. Best results. Promptness assured. Watson E. Coleman, Patent Lawyer, 724 9th Street, Washington, D. C.

**Patents and Inventions Wanted**

INVENTIONS COMMERCIALIZED. Patented or unpatented. Write Adam Fisher Company, 278 Enright, St. Louis, Missouri.

**Personal**

WANTED original poems, songs, for immediate consideration. Send poems to Columbian Music Publishers, Ltd., Dept. 293, Toronto, Can.

**Radio**

HOW TO WRITE Radio Scripts. Dime, and stamp. G. N. Alworth, Publisher, 2019 Highland Ave., Knoxville, Tenn.

AMATEURS. Bulletin describing efficient, stable, and inexpensive 5 meter long lines oscillator yours. Write Paradio Sales Co., 124 Garrison Ave., Jersey City, N. J.

RADIO. Engineering, broadcasting, aviation and police radio, service, marine and Morse telegraphy taught thoroughly. All expenses low. Catalog free. Dodge's Institute, Elm St., Valparaiso, Ind.

**Radio Instruction**

COMPLETE TRAINING for all Amateur and Professional Radio Licenses. New York Wireless School, 1123 Broadway, New York.

**Salesmen Wanted**

WANTED COUNTY DISTRIBUTORS. Excellent opportunity for earnings. Nationally advertised product. Large company. Dept. 292 Fyr-Fyter Company, Dayton, Ohio.

**INDEX TO ADVERTISERS**

Aerovox Corp.	444	Million Radio & Television Lab.	438
Akrad Products Co.	446	Models	427
Aladdin Radio Industries, Inc.	442	Montgomery Ward	437
Allied Radio Corp.	425	National Radio Institute	385
American Transformer Co.	438	National Schools	442
Amperite Corp.	423	National Union Radio Corp.	Inside Back Cover
Arrow Sales Co.	444	N. Y. YMCA Schools	432
Brush Development Co., The	442	Pipe and Tobacco Guild, Inc., The	428
Bud Radio, Inc.	444	RCA Institutes, Inc.	430
Burstein-Applebee Co.	442	Radio City Products Co.	448
Cameradio Co.	432	Radio Constructors Labs.	433
Candler System Co., The	430	Radio Service Institute	448
Capitol Radio Engineering Institute	446	Radio & Technical Publishing Co.	423, 432, 434
Central Radio Laboratories	430	Radio Training Association of America	436
Chicago Wheel & Mfg. Co.	433	Radolek Co., The	447
Cornell Dubilier Corp.	440	Raytheon Production Corp.	435
Coyne Electrical School	441	Readrite Meter Works	440
Dodges Institute	438	John F. Rider	439
Electronic Publishing Co.	429	Scott Radio Labs., Inc., E. H.	434
Goldentone Radio Co.	438	Sevan Co.	445
Gordon Specialties Co.	436	Silver Corp., McMurdo	433
Hallcrafters' Inc.	Back Cover	Solar Mfg. Corp.	429
Hammarlund Mfg. Co., Inc.	443	Sprayberry Academy of Radio	389
Hetro Electrical Industries, Inc.	443	Standard Transformer Corp.	425
Hygrade Sylvania Corp.	424	Superior Instruments Co.	437
Instructograph Co.	444	Supreme Instruments Corp.	429
International Correspondence Schools	445	Teleplex Co.	425
Kato Engineering Co.	434	Triad Mfg. Co., Inc.	436
Kenyon Transformer Co., Inc.	437	Trimm Radio Mfg. Co.	423
Lincoln Engineering School	434	Triplett Electrical Instrument Co.	422
Mallory & Co., Inc., P. R.	390	Tri-State College	428
Midland Television, Inc.	421	Try-Mo Radio Co., Inc.	448
Midwest Radio Corp.	428	Weston Electrical Instrument Corp.	426
		Wholesale Radio Service Co.	431
		Wright-DeCoster Co., Inc.	447
		Zephyr Radio Co.	448



## The DX Corner (Broadcast Band)

(Continued from page 433)

1370	WABY	All night
1410	WAAB	All night
1460	KSTP	to 3:00 a.m.
1500	WJBK	All night

Observer Routzahn adds the following stations in the all night category: WIND, 560 kc, and WEXL, 1310 kc.

### New Zealand Changes

Observer Watson of New Zealand writes that 3ZB at Christchurch is now on the air on 1430 kc., using 1 kw. power. 4ZB of Dunedin is also now on the air on 1220 kc. with 1 kw. 3ZM is off the air.

### Japanese List

Observer Randolph Hunt submits the latest list of JO's. Many of them he has personally checked. An asterisk beside the frequency of a station indicates that a Japanese station has been heard by Observer Hunt on that frequency. An asterisk following the call letters indicates that he has definitely identified the stations during recent weeks.

Kc.	Call	Location
580	JFCK	Taichu, Taiwan
*590	*JOAK1	Tokyo
*600	JONG	Miyazaki
*610	JOJK	Kanazawa
630	JOKK	Okayama
640	JODG	Hamamatsu
650	JOUK	Akita
*670	JOTK	Matsuye
*680	JOVK	Hakodate
*690	JBBK1	Osaka
*700	*JOCG	Ashigawa
710	JODK1	Keijo, Korea
JORK	Kochi	
720	JFBK	Tainan, Taiwan
*730	JOCK1	Nagoya
*740	*JOSK	Kokura
*750	*JFAK	Taihoku, Taiwan
*770	JOHK	Sendai
*780	*JOPK	Shizuoka
*790	JOJK	Kumamoto
*810	JOIK	Sapporo
*820	*JBBK2	Heijo, Korea
*830	JOFK	Hiroshima
*850	JBCK	Seishin, Korea
*870	JOAK2	Tokyo
*890	*JOLG	Tottori
*910	JOLK	Fukuoka
*920	JOJK	Niigata
*930	*JOAG	Nagasaki
*940	*JOBK2	Osaka
950	JOOG	Obihiro
*970	JODK2	Keijo, Korea
*980	JOKK	Tokushima
*990	JOCK2	Nagoya
1000	JOBG	Maebashi
*1020	*JOFG	Fukui
1030	JBAK	Fusan, Korea
1040	JONK	Nagano
*1050	JOHG	Kagoshima
*1060	JOIG	Toyama
1070	JOOK	Kyoto
1080	JOJK	Yamagaya
1090	JBBK1	Heijo, Korea

## Amateur Observer

(Continued from page 439)

3ZB-8, 4HG-6, 4HJ-6, 4LX-7, 4RF-8, 5LL-8, 5WR-7, 6CA-5, 7DH-7, 7KR-7, 7LZ-7, 7YL-7, VP1AA-9, 1RB-8, 5ST-9, YN-AA-8, YU1XX-6, ZL1BC-7, 1DV-7, 1LZ-7, 1LM-7, 1MR-8, 2CI-7, 2DS-7, 2GN-8, 2PM-8, 2QA-7, 4AC-7, 4GM-5, ZS1AN-7, ZU2G-7, 2B-7, 6E-7.

20 meter phone: CNSAM-6, EASAE-8, 9AH-7, FA3HC-7, K6NZO-8, 6OQE-8, SM7YA-7, SU1CH-8, VK2ADA-7, 2VV-5, 4JU-6, 5JS-8, VO1I-9, 1P-8, 2N-9, 2Z-9, 6L-9, VP2AT-8, YU7AX-6, OX2QY-8.

By Clarence Hartzell, 1 N. 6th Street, Overbrook, Jeannette, Pa.

10 meter phone: G2KH-6, 6BW-6, 6DL-5, 6GO-1, 6DH-7, 6BJ-8, F3CX-6, 8HL-5, GM6RG-9, ON4SD-5, E19J-8, J6AK-7, PAOUV-6, ZS1AY-5.

20 meter phone: G2AL-6, 2DP-5, 2MK-7,

2ML-6, 2RH-4, 2AV-5, 5RJ-6, 5CM-4, 5IK-7, 6AW-5, 6LS-7, GW6KY-4, CT3AN-5, CNSAA-4, SMO-3, ASL-6, PAOAA-5, OFB-6, OTL-4, VO6D, KA1OR-3, 1AL-4, VK2WH-3, 2OK-7, 2NO-5, 2IJ-4, 2DK-5, VK3WA-5, 3VW-6, 3RA-4, 4WO, ZS8A-5, SM5SD-7, VP7NA-6, T13RE-6, LU1CA-9, 2CA-5, 5BZ-7, PK1MX-5, 2WL-3, YV5ABD-9, 5AD-7, 5AI-8, PY2AK-6.

By Chris Davis Jaffe, Algonquin Park, Norfolk, Va.

10 meter phone: K5AT-7, 6MVV-5, VK2GU-7, GM6RG-9, G2PU-6, LHQ-5, 5ML-9, 6GF-6, ZS6AJ-6, PAOFB-7, ZU6P-7, ZT6A-4.

20 meter phone: EA9AH-9, CNSAM-9, 8AJ-5, SAL-6, ZT5P-8, 6Y-4, ZS5AB-7, ZUIT-6, 6N-7, ZE7JB-5, FR8VX-3, SU1GD-5, OQ5AA-5, G2MF-6, 2ML-6, 2PU-7, 5N1-9, 5ML-9, 5JO-5, 5TP-6, 5SP-7, 5BM-8, 6IA-6, 6XR-9, 6GF-5, SMX-7, SLP-6, HA8N-6, ON4VK-6, 4SS-5, PAOMO-5, EI2L-8, 3J-4, YL2BA-5, F3KH-6, SXT-5, CT1PC-6, XUSMC-5, VS1A1-6, 1AA-7, XW6A-6, PK1JJ-7, 1VN-4, 2AE-5, 2ABD-7, 2RJ-7, 2HF-5, 3AL-6, 6MU-8, OX2QY, W10XAB.

By Homer Bohlender, R. R. 2, Brookville, Ohio.

10 meter phone: VK2GU-6, K6MVV-8, ZE1JR-6, 1JY-6, GM6RG-6, G2IT-5, 2KU-7, 5VM-7, 5BM-6, 5AU-6, 5KH-7, 6GF-6, 6BW-7, 6DH-7, 6GO-6, 6VX-6, 6LL-7, 6WY-7, 8FZ-6, GW2UL-7, ZT6J-6, 6Y-5, 6AK-6, ZS6AH-6, 6T-6, F3LH-6, 3KH-7, SLX-6, EI2L-8, NY2AE-7, LU7AG.

20 meter phone: VK2VV-6, 2HS-7, 2BO-7, 2UC-8, 2ADU-6, 2TC-7, 2NO-7, 2AZ-8, 2CP-5, 2QI-5, 2AFQ-7, 2ADE-6, 2OG-7, 2IO-6, 2AP-7, 2MH-6, 2VB-6, 2BK-6, 2DK-6, 3MX-7, 3WD-7, 3ZZ-6, 3KR-8, 3RE-8, 3KX-7, 3XJ-8, 3ZL-7, 3NP-6, 3GO-6, 3CE-6, 3BZ-6, 4VD-7, 4JU-8, 4JX-6, 4BB-7, 5DC-7, 5AC-7, 6MU-6, 6WS-6, K6OQE-8, 6KMB-8, 6MXX-8, 6BNR-8, 6MZK-7, YV4AB-7, 4AX-7, 4AF-7, 5AG-8, 5AK-8, 5AM-7, 5AA-6, 5ABF-6, 5ABO-7, G5ML-8, 5TZ-7, 5NI-7, 5SP-6, 5BJ-7, 6XR-8, 6DT-6, 6BW-6, 6OL-6, 6TF-7, 6AI-7, 6MX-6, 6SX-6, HCF1G-8, 1JB-7, ZU6P-7, ZS2N-6, 2X-6, 3P-5, 6S-7, F3IX-6, 3OO-7, 8KW-6, SPW-6, EI2L-7, NY2AE-7, CNSAJ-8, LU1CA-6, 1HI-6, 7AC-6, 8AB-5, 9BV-7, OA4C-6, OA4AL-7, VO6L-7, 6D-7, HK1EP-7, 3JB-6, 4AG-6, PY5AQ-6, EA9AH-8, VP7NA-7, CT1AY-7.

By Ray Bayer, 2314, La Salle Street, Racine, Wis.

20 meter c.w.: CX2BK-5, D3CSC-4, 4BFU-5, FSKW-5, FASDA-5, FY8B-3, G2MA-3, ZZY-8, 5YH-4, 6JZ-4, 6RO-6, 8BD-7, HCUJW-6, 1IIR-4, K5AA-8, 5AC-9, 5AE-7, 5AG-6, 6OKN-6, 7BOE-5, LU2EG-5, OA4J-4, OE1FH-5, OH5OA-4, ON4GK-7, 4KM-4, 4RX-6, ON2OY-7, OZ7UU-3, PY2AC-3, SAH-5, UIAD-3, 2NE-5, 3BC-3, VK2ADE-5, 2DG-4, 2QE-6, 3IW-5, 3MR-6, 4JX-8, 5LL-6, 5VR-4, 5WR-4, 7YL-5, YM4AA-3, YN1AA-5, YU7XX-3, YV2CU-3, ZL1HY-6, 1MR-4, 2CI-5, 2QA-3, ZS1ANI-3, ZU6U-4.

20 meter phone: HH2B-5, HK1EP-6, 3HA-8, LU4BA-5, K6OQE-7, 6NZJ-6, NY2AE-9, OA4AI-5, 4C-5, SU1CH-6, 1SG-6, SM5SV-4, T12PK-9, 2OFR-6, 3RE-6, OX2QY-7, VO6D-7, VP9R-7, VK2AC-3, 3KX-4, YV4AA-5, 5AB-4, 5ABF-6, 5AK-4.

By Burnell Nnger, 525 Frederick Street, Hanover, Pa.

20 meters: TI7LF-5, NY2AE-7, K6OQE-6, OX2OY-7, UP3BG-7, VO6L-5, G5NI-8, HK3MD-5, YU3AM-5, 8AA-8, 4FS-5, 5AE-4, 5AA-3, 5AK-7, HJ1AP-6, 3MP-4, VK2AXQ-2, 2VV-4, 2MU-3, 2CE-4, 2AR-3, 4BG-3.

## Home-Made Speaker Cement

A quick-drying radio cement can be easily made at a small cost by mixing equal quantities of collodion and banana oil. Experimenters will find this cement not only useful for speaker repairs but also successful for coating r.f. coils, chokes, etc. In an emergency, liquid nail polish can be used as a radio cement but its cost is prohibitive for big jobs. When storing the cement be sure it is kept in an air tight can or bottle. Collodion can be purchased at most drug and hardware stores.

HAROLD MILLEN  
Roxbury, Mass.

## NEXT MONTH

Experimenters who are interested in building a receiver that will give them High-fidelity reception on the Broadcast band will be interested in Mr. Adams' receiver to be described in February.

## TECHNICIANS

ability to furnish custom built inter-communication systems when using Talk-Bak\* Units is one reason for their great popularity.



Attractive Model T.B.U. 1700 Size 6 1/2" diameter 3" high

### FREE New Technical and Sales Pamphlet

gives complete information regarding all known inter-communication systems. Method of connecting different Talk-Bak\* Units and full detailed information on what they will accomplish. Write for it and be sure to include your distributors' name.

Wright-DeCoster Distributors are always anxious to cooperate.

## WRIGHT-DeCOSTER, Inc.

2255 University Ave., St. Paul, Minn.

Export Dept.: M. Simons & Son Co., New York

Circle Address: "Simontrive"

Canadian Representatives:

Wm. F. Kelly Co., 1207 Bay St., Toronto, Ont., Taylor & Pearson, Ltd., Edmonton, Alberta

\*Copyrighted

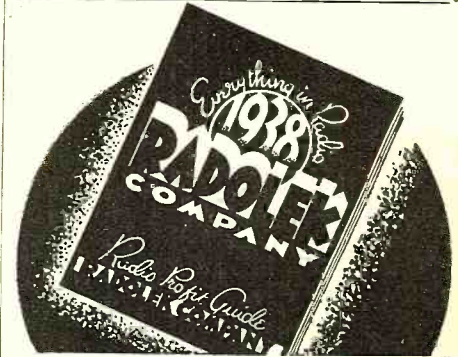

LOWEST PRICES

The New 1938 Radolek Radio Profit Guide contains complete showings of Radio Repair Parts; every repair part for every receiver; Newest Radio Receivers in a complete price range; New 1938 models of Public Address Amplifiers; outputs from 5 to 100 watts—Speakers, Microphones, Test Instruments, Technical Books, Special Tools, Leading Standard Brands! Everything you need in the Radio Business all at Lowest Prices. You save money at Radolek!

GUARANTEED QUALITY

Every item you get from Radolek is guaranteed. It must be right or we make it right. Standard merchandise produced by leading manufacturers with Radolek's guarantee added!

FASTEST SERVICE

Everything in Radio promptly when you want it—and exactly what you want. Radolek's efficient organization insures you the fastest service in the Radio business. 25,000 servicemen customers depend on Radolek service and benefit by Radolek's LOWEST PRICES.

Send now for Radolek Radio Profit Guide. It will help you make money.



**VALUE PLUS...**  
Elgin 800 Tube Tester

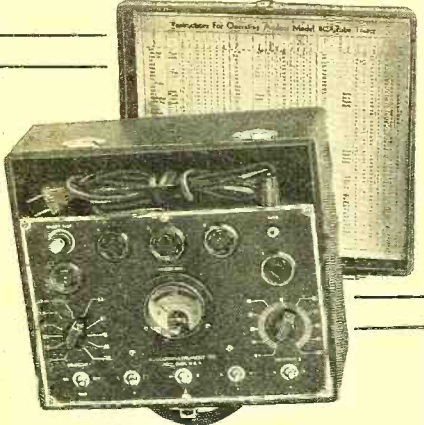

- Tests All Tubes including Metal
- D'Arsonval Moving Coil Meter
- English Reading "Good-Bad" Scale
- Separate Section Tests
- Accurate Tests on All Tubes
- Portable Leatherette Covered Case
- Compact—Can be Carried Anywhere
- Requires But Two Settings For Tests
- Combination Short Test and Meter Fuse
- Chart For Testing All Tubes

Complete Net Dealer's and Serviceman's Price..... **\$11.50**

**MODEL 801 Volt-Ohmmeter**

A sensitive, compact and accurate volt-ohmmeter that will be the busiest instrument in your "lab." or out on jobs. DC voltage readings -0.5-50-500 and 1000 - resistance readings from 1/2 to 500 and 200 to 500,000 ohms. Will read from 0 to 1 Ma. Low resistance range direct reading. Meter has 1000 ohm per volt sensitivity. Battery is self contained. Panel is clearly lettered. Compensator provided for zero adjustment. Measures only 5" x 3 1/4" x 2 1/2"

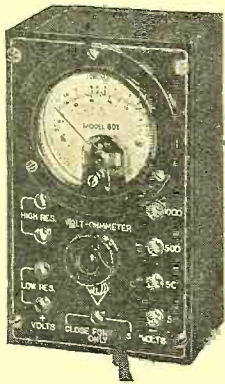

DEALER'S NET PRICE WITH BATTERY..... **\$5.75**

SEND FOR NEW 1938 CATALOG  
**TRY-MO RADIO CO., INC.**  
85N CORTLANDT ST., N. Y. C.

**Servicemen WHO WANT TO GET AHEAD**

Here's the "Key to Successful Servicing"! An advanced home study course of training for professional servicemen in Radio Service and Public Address, with or without Television. Terms as low as \$5 monthly. Our free booklet gives complete details that will interest every ambitious man—write today.

Write For **FREE BOOKLET**

**RADIO SERVICE INSTITUTE**  
Dept. RN1-3308 14th St., N. W.--Wash., D. C.

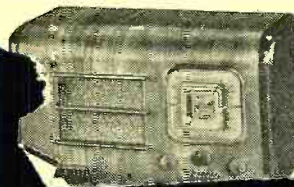

**SAVE UP TO 50%**  
1938 Models Latest Features  
**MONEY BACK GUARANTEE**  
Free Catalog  
Zephyr Radio Co.  
13129 Hamilton

**At Your Dealer's**

(Continued from page 435)

made for easy and quick installation. The aerial is constructed of wide, semi-rounded strips to afford signal pickup. Flowing arrow-like lines and the highly polished finish of the antenna make it harmonize nicely with the new cars.

**Using the Slide Rule for Radio Calculations**

Many radio experimenters will appreciate the following pertinent information taken from the "Aerovox Research Worker" on the use of the slide rule for radio calculations. Due to the limited space in this department it will not be possible to give the entire data in the one issue; simple examples showing short-cuts in ordinary multiplication and converting wavelength to frequency are outlined in this first composition, to be followed in subsequent issues of the magazine with equations, involving vacuum tubes, alternating current bridges, power dissipation, etc.

There is no doubt that the slide rule enables one to solve mathematical equations speedily and with sufficient accuracy. Yet it is not being used as much as it might be and its full possibilities are seldom utilized. This surprising condition is probably due to a lack of familiarity with short cuts and a lack of practice in using the rule. Very often the product of three factors and even more, can be found by a single setting of the slide while the average man will probably change settings two or three times.

This article aims to show the quickest way of obtaining solutions to typical equations employed in the radio art. This is not intended as an elementary text on the use of the slide rule; it is assumed that the reader is familiar with his rule and that he is able to perform the usual computations. It is merely intended to show applications to radio since this field of endeavor never seems to be covered in instruction books.

The question arises: What type of rule appears the most suitable? The examples below will illustrate that considerable time can be saved by the use of folded and inverted scales. Rules having the inverted, folded and inverted-folded scales are the "polyphase-duplex" and the "log-log-duplex." Some work requires log-log scales and trigonometric scales. However, in order to be of universal aid, the following instructions will apply to the "polyphase-duplex" scale and special hints will be given for the benefit of those who have rules with an inverted scale but without folded scales. Such a rule is the "polyphase." The identification of each scale on the rule will be by letter, familiar to all who possess a slide-rule.

**Ohm's Law**

$$E = IR, \quad I = E/R, \quad R = E/I$$

If I and R are given, the result can be obtained in several ways. The first one is illustrated in Figure 1a. This is ordinary multiplication using the C and D scales. Figure 1b shows the solution for the case when E would fall beyond the limits of the D scale. An alternative way of obtaining the same result is by means of the inverted scale CI and the D scale. This is illustrated in Figures 1c and 1d. Set I on scale CI to R on scale D and read E at either the right or left index of CI on scale D. In some cases this would result in drawing the slide nearly completely out of the stock. It is in such cases that the folded scales serve

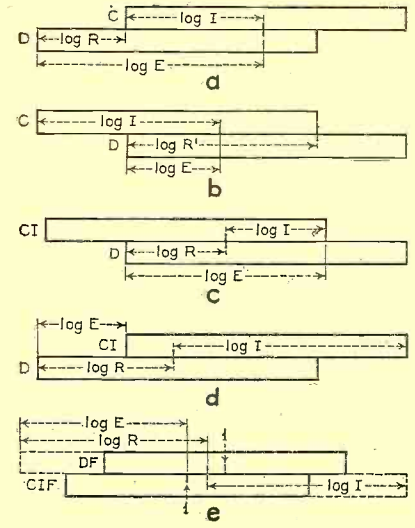

admirably. For the sake of accuracy and speed the slide should always remain at least half-way in the rule. Whenever the use of scales C or D or CI and D would require a greater movement of the slide, it will be found that the same problem can be solved using CF and DF or CIF and DF without having to move the slide too far. As an illustration, the case of Figure 1d is shown again using scales CIF and DF, Figure 1e. Also, in the case of Figure 1a, when E falls beyond the limit of the scale D, if folded scales are provided it is not necessary to reset the slide to the position of Figure 1b. Instead, find I on scale CF and opposite this mark the answer, E, is found on DF.

In all examples of Ohm's law when E is given together with R or I it will be found most expedient to employ the settings of Figure 1c or 1e. It should be noted also that in certain problems, where it is required to find the current for several different values of resistance across the same voltage, all the answers can be found at a single setting. This would not be true if the settings of Figures 1a and 1b were used; this is the advantage of inverted scales.

**Converting Wavelength to Frequency**

Employing the polyphase slide rule, set the left index of CI to 3 on D. Then find the wavelength corresponding to any frequency on D opposite the frequency on CI or vice versa. This one position of the slide is sufficient to solve all possible conversions from frequency to wavelength and vice versa.

The polyphase-duplex slide rule enables one to employ a folded scale; then the slide need not be moved so far. Set 1 on CIF to 3 on D, then the corresponding values of wavelength and frequency are found opposite each other on the CIF and the D scales. It is also possible to use the CI and DF scales, setting 3 on CI to 1 on DF.

**Smart Kink for Tagging Resistors**

Checking back a number of old fixed resistors, I found it very difficult to determine their value due to the fading and chipped enamel; and of course the accumulation of dirt was no help. To reclaim these units, their resistance was checked on an ohmmeter and the values written on a small piece of adhesive tape which was pasted around the resistor. I found this a worthwhile kink for quickly determining the values of resistors. I am applying this tag idea to new resistors as well.

WM. CHALMERS  
Chicago, Illinois.



# NOW! NATIONAL UNION CONDENSERS ELECTROLYTICS and PAPERS

*New N. U. Plus Profit Products for Radio Service Experts*

HERE'S SENSATIONAL good news for Radio Service Specialists! The same superior quality . . . the same plus profit opportunities which make NATIONAL UNION RADIO TUBES outstanding choice in the Service Profession are here in this new line of Condensers. NATIONAL UNION has spent years working . . . building with you. National Union knows the kind of merchandise you demand. It is here in these new condensers with built-in quality and guaranteed performance. The chance to build your business bigger and faster is here too. Get details from your distributor today. Start now to cash in on N. U. Condensers as well as N. U. Tubes.



**GET DETAILS FROM YOUR N. U. D**

OR WRITE

**NATIONAL UNION RADIO CORPORATION, 570 LEXING**



WIDE RANGE VARIABLE

Selectivity

TONE CONTROL

A.C. ON  
OFF

B.F.O. INJECTOR

REC. SE43

A.F. GAIN

R.F. GAIN

EXPANDER  
BROAD SHARP

PITCH CONTROL

CRYSTAL  
OUT IN

CRYSTAL PHASING

*RAZOR SHARP*  
TO BROAD HIGH FIDELITY

SELECTIVITY, important in a communications receiver, is highly developed in the 1938 Super Sky-rider. New improved iron core I. F. transformer circuits allow Wide Range Variable Selectivity, from "razor-sharpness" to broad "High Fidelity" (8.7 KC to 20.0 KC at 100 time down). With crystal in circuits, selectivity is better than one KC, providing a variable selectivity ratio of over 30 to 1, and offering true communications receiver performance. Write today for descriptive bulletin on the New 1938 SUPER SKYRIDER.

All Hallicrafters Receivers now available on Liberal Time Payments.

**the hallicrafters inc.**

2603 Indiana Avenue, Chicago, Ill. • Cable Address "Hallicraft" Chicago  
World's Largest Manufacturer of Amateur Communications Equipment